

40
★ ★ ★ ★ ★
YEARS

SOUTH INDIA'S

NO. 1 BRAND IN
PIPES AND FITTINGS

PRODUCT CATALOGUE
2024



PIPE & FITTINGS | SANITARYWARE | BATHWARE | WATER TANKS | STAR FLEX | STARPAULIN

CORPORATE OFFICE : Kanjani Road,, Ayyanthole. PO, Chungam,, Thrissur, Kerala 680003
Phone: 0487-2386762, Email: info@starpipes.in

DREAMS AND
REALITY AS
DEFINED BY
STAR





In the footprints of great men lie the direction of progress of society; And the dreams of great men inspire the destiny of a nation...



Our guiding star
Late P.K.Paul

Star, an ISO 9001, 14001 certified company traces its lineal roots to the prescience, the insight, the commitment of a man who believed in pitching his dreams beyond the confines of the banal.

Clarity of vision and the foundation of assiduity has made Star grow from strength to strength to its acme now when it is indeed glittering on the industrial firmament of excellence with merchandise of global standards. Rigid PVC pipes, pipe fittings, flexible hose, building materials...

After the accolades rang in loud and clear, came the official commendation in 1988, indeed our coronation, Star became the first PVC Pipe fittings manufacturer in South India to be crowned with the ISI mark for quality. From then on, Star has been continually straining its sinews to up the benchmark of quality through sedulous research and unstinting commitment to values.

Our history now is a laudable enumeration indeed-In 1994 Star flex, flexible hose for domestic and industrial use, was born. In 1998 the strategic decision to step out of its regional theatre to become a global player was taken. The brand name Star Impex was registered and Dubai chosen as the nodal centre for overseas operations. With the supremacy of our products, market ascendancy was not difficult. Star now is a ubiquitous presence in the entire Middle-east and South Africa. In 2001, Star received the ISO 9002 certification, yet again, the first in South India.

And recently, Star ensconced another milestone in its long path of glory by setting up two Rigid PVC plants in 2004; one in Kerala and the other in Tamil Nadu. With a combined capacity of around 17000 tpa of finished products, Star has the capacity and quality to live up to the ever-growing requirements of customers.



Water Management

Providing safe drinking water to 6 billion plus earthlings in the future calls for effective and innovative water management. With a wide range of products, STAR is contributing in its own way to this cause. STAR products are used to enhance the efficiency of water management systems in various parts of the globe.

40
★ ★ ★ ★ ★
YEARS



PIPE & FITTINGS | SANITARYWARE | BATHWARE | WATER TANKS | STAR FLEX | STARPAULIN

Star has a comprehensive range of UPVC pipes, fittings and accessories catering to the various needs of sanitation and drainage system





star
PIPES & FITTINGS

CPVC Pipes & Fittings &

STAR CPVC plumbing system is designed for Hot & Cold water which is suitable for all plumbing and potable water application. It can be used for distribution of water from 0 to 93 °C. Its corrosion resistance property makes it usable in all weather & ensures constant flow.

Star CpvC fittings - ATM D 2846 (SDR 11)

Coupler



Size in MM	inch
15 mm	1/2
20 mm	3/4
25 mm	1
32 mm	1 1/4
40 mm	1 1/2
50 mm	2
65 mm	2 1/2
80 mm	3
100 mm	4

End Cap



Size in MM	inch
15 mm	1/2
20 mm	3/4
25 mm	1
32 mm	1 1/4
40 mm	1 1/2
50 mm	2
65 mm	2 1/2
80 mm	3
100 mm	4

Elbow 90°

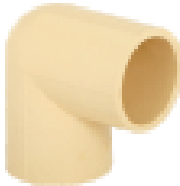

Size in MM	inch
15 mm	1/2
20 mm	3/4
25 mm	1
32 mm	1 1/4
40 mm	1 1/2
50 mm	2
65 mm	2 1/2
80 mm	3
100 mm	4

Elbow 90° CPVC Threaded



Size in MM	inch
20x15	3/4x1/2

Elbow 45°



Size in MM	inch
20 mm	3/4
25 mm	1
32 mm	1 1/4
40 mm	1 1/2
50 mm	2
65 mm	2 1/2
80 mm	3
100 mm	4

Elbow 90° Brass



Size in MM	inch
20x15	3/4x1/2
25x15	1x1/2
25x20	1x3/4
20x20	3/4x3/4
25x25	1x1

Equal Tee



Size in MM	inch
15 mm	1/2
20 mm	3/4
25 mm	1
32 mm	1 1/4
40 mm	1 1/2
50 mm	2
65 mm	2 1/2
80 mm	3
100 mm	4

RMTA Brass



Size in MM	inch
25x25	1x1
32x32	1 1/4x1 1/4
40x40	1 1/2x1 1/2
50x50	2x2
65x65	2 1/2x2 1/2
80x80	3x3
100x100	4x4

HEXAGON BRASS MTA



Size in MM	inch
25x25	1x1
32x32	1 1/4x1 1/4
40x40	1 1/2x1 1/2
50x50	2x2

RFTA Brass



Size in MM	inch
20x15	3/4x1/2
25x15	1x1/2
25x20	1x3/4
20x20	3/4x3/4
25x25	1x1
32x32	1 1/4x1 1/4
40x40	1 1/2x1 1/2
50x50	2x2
65x65	2 1/2x2 1/2
80x80	3x3
100x100	4x4

HEXAGON BRASS FTA



Size in MM	inch
20x15	3/4x1/2
20x20	3/4x3/4
25x25	1x1
32x32	1 1/4x1 1/4
40x40	1 1/2x1 1/2
50x50	2x2

Reducing Th Tee Brass



Size in MM
20x20x20
20x20x15
25x25x15
25x25x20

Reducing TEE



Size in MM
20x20x15
25x25x15
25x25x20

Reducing F TEE



Size in MM
20x15

Union



Size in MM	inch
20 mm	3/4
25 mm	1
32 mm	1 1/4
40 mm	1 1/2
50 mm	2

Tank Nipple



Size in MM	inch
20 mm	3/4
25 mm	1

Tank Nipple
Plain Socket



Size in MM	inch
20 mm	3/4
25 mm	1

MTA CPVC



Size in MM	inch
15 mm	1/2
20 mm	3/4
25 mm	1
32 mm	1 1/4
40 mm	1 1/2
50 mm	2

Threaded
MTA CPVC



Size in MM	inch
20x15	3/4x1/2

FTA CPVC



Size in MM	inch
15 mm	1/2
20 mm	3/4
25 mm	1
32 mm	1 1/4
40 mm	1 1/2
50 mm	2

Threaded
FTA CPVC



Size in MM	inch
20x15	3/4x1/2

Reducing Bush



Size in MM	inch
20x15	3/4x1/2
25x15	1x1/2
25x20	1x3/4
32x15	1 1/4x1/2
32x20	1 1/4x3/4
32x25	1 1/4x1
40x15	1 1/2x1/2
40x20	1 1/2x3/4
40x25	1 1/2x1
40x32	1 1/2x1 1/4
50x15	2x1/2
50x20	2x3/4
50x25	2x1
50x32	2x1 1/4
50x40	2x1 1/2
5x50	2 1/2x2
80x50	3x2
80x65	3x2 1/2
100x50	4x2
100x65	4x2 1/2
100x80	4x3

Size in MM	inch
20x15	3/4x1/2
25x15	1x1/2
25x20	1x3/4
32x20	1 1/4x3/4
32x25	1 1/4x1
40x20	1 1/2x3/4
40x25	1 1/2x1
40x32	1 1/2x1 1/4
50x25	2x1
50x32	2x1 1/4
50x40	2x1 1/2

Size in MM	inch
20 ml	Tube
29.5 ml	Tube
50 ml	Tube
50 ml	Tin
118 ml	Tin
237 ml	Tin

Reducing Coupler



Star Bond
CPVC Solvent



Clamp



Size in MM	inch
20 mm	3/4
25 mm	1

Size in MM	inch
15 mm	1/2
20 mm	3/4
25 mm	1
32 mm	1 1/4
40 mm	1 1/2
50 mm	2

CPVC
Clamp

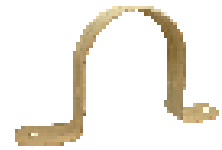

Reducing Plain elbow



Size in MM	inch
20x15	3/4x1/2
25x20	1x3/4

Cross Tee



Size in MM	inch
20 mm	3/4
25 mm	1



Size in MM	inch
20 mm	3/4
25 mm	1

Step Over Bend

Long Plug



Size in MM	inch
15 mm	1/2

End Plug



Size in MM	inch
20 mm	3/4
25 mm	1

Concealed Valve
Square knob
Qtr Turn,
Full Turn



Size in MM	inch
20 mm	3/4
25 mm	1

Concealed Valve
Triangle knob
Qtr Turn,
Full Turn



Size in MM	inch
20 mm	3/4
25 mm	1

Concealed Valve
Fragrance
Knob



Size in MM	inch
20 mm	3/4
25 mm	1

3 in 1 Mixer Adapter
(All top & Top and bottom)

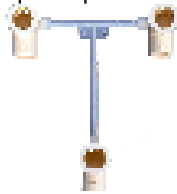

Size in MM	inch
20x15mm	3/4x1/2

Size in MM	inch
25 mm	1
40 mm	1 1/2
50 mm	2
65 mm	2 1/2
80 mm	3
100 mm	4

Vastone Flange



Ball Valve



Size in MM	inch
15 mm	1/2
20 mm	3/4
25 mm	1
32 mm	1 1/4
40 mm	1 1/2
50 mm	2

SDR - 09 CPVC Pipes



Size in MM	inch
20 mm	3/4
25 mm	1

SDR - 11 CPVC Pipes

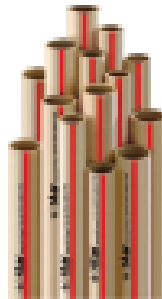

Size in MM	inch
15 mm	1/2
20 mm	3/4
25 mm	1
32 mm	1 1/4
40 mm	1 1/2
50 mm	2

SDR - 13.5 CPVC Pipes



Size in MM	inch
15 mm	1/2
20 mm	3/4
25 mm	1
32 mm	1 1/4
40 mm	1 1/2
50 mm	2

SDR - 40 CPVC Pipes



Size in MM	inch
65 mm	2 1/2
80 mm	3
100mm	4

SDR - 80 CPVC Pipes



Size in MM	inch
65 mm	2 1/2
80 mm	3
100mm	4

UPVC PIPES & FITTINGS

star uPVC plumbing system is a LEAD FREE solvent weld system designed for distribution of potable water. The system is technically superior and offers many advantages over conventional G.I piping system. It is easy to install and offers a long service life. It can be used for the distribution of water in residential, commercial and large industrial complexes. Fitting are made as per ASTM-D 2466 FOR SCH40 & ASTM-D 2467 SCH 80

Tee



Size in MM	inch
15 mm	1/2
20 mm	3/4
25 mm	1
32 mm	1 1/4
40 mm	1 1/2
50 mm	2
65 mm	2 1/2
80 mm	3
100 mm	4

Reducing Tee



Size in MM	inch	Size in MM	inch
20x15	3/4x1/2	40x20	1 1/2x3/4
25x15	1x1/2	40x25	1 1/2x1
25x20	1x3/4	40x32	1 1/2x1 1/4
32x15	1 1/4x1/2	50x20	2x3/4
32x20	1 1/4x3/4	50x25	2x1
32x25	1 1/4x1	50x32	2x1 1/4
40x15	1 1/2x1/2	50x40	2x1 1/2



Brass Threaded Tee



Size in MM	inch
15	1/2
20	3/4
25	1
20x15	3/4x1/2
25x15	1x1/2
25x20	1x3/4
25x25	1x1

Reducing Coupler



Size in MM	inch
20x15	3/4x1/2
25x15	1x1/2
25x20	1x3/4
32x20	1 1/4x3/4
32x25	1 1/4x1
40x20	1 1/2x3/4
40x25	1 1/2x1
40x32	1 1/2x1 1/4
50x15	2x1/2
50x20	2x3/4
50x25	2x1
50x32	2x1 1/4
50x40	2x1 1/2

Size in MM	inch
20X15	3/4x1/2
25X15	1x1/2
25X20	1x3/4
32X20	1 1/4x3/4
32x25	1 1/4x1
40x25	1 1/2x1
40X32	1 1/2x1 1/4
50X32	2x1 1/4
50X40	2x1 1/2

Reducing elbow 90°



Reducing Bush

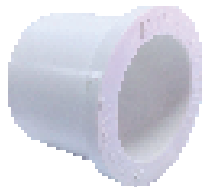

Size in MM	inch
25x15	1x1/2
25x20	1x3/4
32x20	1 1/4x3/4
32x25	1 1/4x1
40x15	1 1/2x1/2
40x25	1 1/2x1
40x32	1 1/2x1 1/4
50x25	2x1
50x32	2x1 1/4
50x40	2x1 1/2
65x50	2 1/2x2
80x50	3x2
80x65	3x2 1/2
100x50	4x2
100x65	4x2 1/2
100x80	4x3

Elbow 90°



Size in MM	inch
15 mm	1/2
20 mm	3/4
25 mm	1
32 mm	1 1/4
40 mm	1 1/2
50 mm	2
65 mm	2 1/2
80 mm	3
100 mm	4

Size in MM	inch
15 mm	1/2
20 mm	3/4
25 mm	1
32 mm	1 1/4
40 mm	1 1/2
50 mm	2

End Cap



Elbow 45°



Size in MM	inch
15 mm	1/2
20 mm	3/4
25 mm	1
32 mm	1 1/4
40 mm	1 1/2
50 mm	2
65 mm	2 1/2
80 mm	3
100 mm	4

Size in MM	inch
15 mm	1/2
20 mm	3/4
25 mm	1
32 mm	1 1/4
40 mm	1 1/2
50 mm	2

FTA UPVC



Coupler



Size in MM	inch
15 mm	1/2
20 mm	3/4
25 mm	1
32 mm	1 1/4
40 mm	1 1/2
50 mm	2
65 mm	2 1/2
80 mm	3
100 mm	4

Reducing brass threaded elbow



Size in MM	inch
15 mm	1/2
20 mm	3/4
25 mm	1
20X15	3/4x1/2
25X15	1x1/2
25X20	1x3/4
25x25	1x1

Size in MM	inch
15 mm	1/2
20 mm	3/4
25 mm	1
32 mm	1 1/4
40 mm	1 1/2
50 mm	2

MTA UPVC



Size in MM	inch
15 mm	1/2
20 mm	3/4
25 mm	1
32 mm	1 1/4
40 mm	1 1/2
50 mm	2

Union

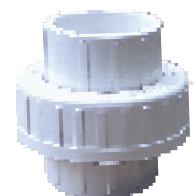

Brass Threaded
FTA



Size in MM	inch
15 mm	1/2
20 mm	3/4
25 mm	1
20x15	3/4x1/2
25x15	1x1/2
25x20	1x3/4
25x25	1x1
32x32	1 1/4x1 1/4
40x40	1 1/2x1 1/2
50x50	2x2
65x65	2 1/2x2 1/2
80x80	3x3
100x100	4x4

Brass Threaded
MTA



Size in MM	inch
15 mm	1/2
20 mm	3/4
25 mm	1
20x15	3/4x1/2
25x15	1x1/2
25x20	1x3/4
25x25	1x1
32x32	1 1/4x1 1/4
40x40	1 1/2x1 1/2
50x50	2x2
65x65	2 1/2x2 1/2
80x80	3x3
100x100	4x4

UPVC Ball Valve



Size in MM	inch
15 mm	1/2
20 mm	3/4
25 mm	1
32 mm	1 1/4
40 mm	1 1/2

Star Brass
Ball Valve



Size in MM	inch
20 mm	3/4
25 mm	1
32 mm	1 1/4
40 mm	1 1/2





PVC PIPES &
FITTINGS





Elbow 90°



Size in MM	inch	Grade
20 mm	½	LW P
25 mm	¾	LW P
32 mm	1	LW P
40 mm	1¼	LW P
50 mm	1½	LW P
63 mm	2	LW P
75 mm	2½	LW P
90 mm	3	LW P
110 mm	4	LW P
140 mm	5	LW P
160 mm	6	LW P

Elbow ISI-10Kg



Size in MM	inch	Grade
20 mm	½	ISI P
25 mm	¾	ISI P
32 mm	1	ISI P
40 mm	1¼	ISI P
50 mm	1½	ISI P
63 mm	2	ISI P
75 mm	2½	ISI P
90 mm	3	ISI P
110 mm	4	ISI P
140 mm	5	ISI P
160 mm	6	ISI P

Elbow ISI-6Kg



Size in MM	inch	Grade
50 mm	1½	ISI P
63 mm	2	ISI P
75 mm	2½	ISI P
90 mm	3	ISI P
110 mm	4	ISI P
140 mm	5	ISI P

Elbow ISI-4Kg



Size in MM	inch	Grade
63 mm	2	ISI P
75 mm	2½	ISI P
90 mm	3	ISI P
110 mm	4	ISI P

Elbow PN 16



Size in MM	inch	Grade
20 mm	½	Pn16 P
25 mm	¾	Pn16 P
32 mm	1	Pn16 P
40 mm	1¼	Pn16 P
50 mm	1½	Pn16 P
63 mm	2	Pn16 P
110 mm	4	Pn16 P

Elbow Socket



Size in MM	inch	Grade
50 mm	1½	LW P
63 mm	2	LW P
75 mm	2½	LW P
90 mm	3	LW P
110 mm	4	LW P
140 mm	5	LW P
160 mm	6	LW P

Door Elbow Socket



Size in MM	inch	Grade
40 mm	1¼	LW P
50 mm	1½	LW P
63 mm	2	LW P
75 mm	2½	LW P
90 mm	3	LW P
110 mm	4	LW P
140 mm	5	LW P
160 mm	6	LW P

Door Elbow Socket Heavy



Size in MM	inch	Grade
50mm	1½	H P
63mm	2	H P

Threaded Elbow



Size in MM	inch	Grade
20 mm	½	Heavy TxP
25 mm	¾	Heavy TxP
32 mm	1	Heavy TxP
40 mm	1¼	Heavy TxP
50 mm	1½	Heavy TxP
63 mm	2	Heavy TxP
75 mm	2½	Heavy TxP
90 mm	3	Heavy TxP
110 mm	4	Heavy TxP



Elbow Macho



Size in MM	inch	Grade
63 mm	2	P
75mm	2½	P
90 mm	3	P
110 mm	4	P
160 mm	6	P

Tee



Size in MM	inch	Grade
20 mm	½	LW P
25 mm	¾	LW P
32 mm	1	LW P
40 mm	1¼	LW P
50 mm	1½	LW P
63 mm	2	LW P
75 mm	2½	LW P
90 mm	3	LW P
110 mm	4	LW P
140 mm	5	LW P
160 mm	6	LW P
180 mm	7	LW P
200 mm	8	LW P

Tee ISI-10kg



Size in MM	inch	Grade
20 mm	½	ISI P
25 mm	¾	ISI P
32 mm	1	ISI P
40 mm	1¼	ISI P
50 mm	1½	ISI P
63 mm	2	ISI P
75 mm	2½	ISI P
90 mm	3	ISI P
110 mm	4	ISI P

Tee ISI-6kg



Size in MM	inch	Grade
50 mm	1½	ISI P
63 mm	2	ISI P
75 mm	2½	ISI P
90 mm	3	ISI P
110 mm	4	ISI P
140 mm	5	ISI P

Tee ISI-4kg



Size in MM	inch	Grade
63 mm	2	ISI P
75 mm	2½	ISI P
90 mm	3	ISI P
110 mm	4	ISI P

Tee PN 16



Size in MM	inch	Grade
25 mm	¾	Pn16 P
32 mm	1	Pn16 P
40 mm	1¼	Pn16 P
50 mm	1½	Pn16 P
63 mm	2	Pn16 P
110 mm	4	Pn16 P

Tee Macho



Size in MM	inch	Grade
63 mm	2	P
75 mm	2½	P
90 mm	3	P
110 mm	4	P
140mm	5	P

Tee Socket



Size in MM	inch	Grade
50 mm	1½	LW P
63 mm	2	LW P
75 mm	2½	LW P
90 mm	3	LW P
110 mm	4	LW P
140 mm	5	LW P

Door Tee (S)



Size in MM	inch	Grade
40 mm	1¼	LW P
50 mm	1½	LW P
63 mm	2	LW P
75 mm	2½	LW P
90 mm	3	LW P
110 mm	4	LW P

Threaded Tee

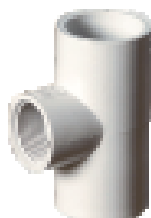

Size in MM	inch	Grade
20 mm	½	Heavy TxP
25 mm	¾	Heavy TxP
32 mm	1	Heavy TxP
63 mm	2	Heavy TxP
75 mm	2½	Heavy TxP
90 mm	3	Heavy TxP
110 mm	4	Heavy TxP

Coupler PN 16



Size in MM	inch	Grade
25 mm	¾	Pn16 P
32 mm	1	Pn16 P
40 mm	1¼	Pn16 P
50 mm	1½	Pn16 P
63 mm	2	Pn16 P
110 mm	4	Pn16 P

Coupler



Size in MM	inch	Grade
20 mm	½	LW P
25 mm	¾	LW P
32 mm	1	LW P
40 mm	1¼	LW P
50 mm	1½	LW P
63 mm	2	LW P
75 mm	2½	LW P
90 mm	3	LW P
110 mm	4	LW P
140 mm	5	LW P
160 mm	6	LW P
180 mm	7	LW P
200 mm	8	LW P

Coupler Full Threaded



Size in MM	inch	Grade
63mm		Heavy T

Flange



Size in MM	inch	Grade
90 mm	3	H P
110 mm	4	H P

MTA



Size in MM	inch	Grade
20 mm	½	H T
25 mm	¾	H T
32 mm	1	H T
40 mm	1¼	H T
50 mm	1½	H T
63 mm	2	H T
75 mm	2½	H T
90 mm	3	H T
110 mm	4	H T
140 mm	5	H T
160 mm	6	H T

MTA PN 16



Size in MM	inch	Grade
25 mm	3/4	Pn16 TxP
32 mm	1	Pn16 TxP
40 mm	1 1/4	Pn16 TxP
50 mm	1 1/2	Pn16 TxP
63 mm	2	Pn16 TxP
110 mm	4	Pn16 TxP

FTA



Size in MM	inch	Grade
20 mm	1/2	H T
25 mm	3/4	H T
32 mm	1	H T
40 mm	1 1/4	H T
50 mm	1 1/2	H T
63 mm	2	H T
75 mm	2 1/2	H T
90 mm	3	H T
110 mm	4	H T
140 mm	5	H T
160 mm	6	H T

FTA Pn16



Size in MM	inch	Grade
25 mm	3/4	Pn16 TxP
32 mm	1	Pn16 TxP
40 mm	1 1/4	Pn16 TxP
50 mm	1 1/2	Pn16 TxP
63 mm	2	Pn16 TxP
110 mm	4	Pn16 TxP

End Cap



Size in MM	inch	Grade
20 mm	1/2	H P
25 mm	3/4	H P
32 mm	1	H P
40 mm	1 1/4	H P
50 mm	1 1/2	H P
63 mm	2	H P
75 mm	2 1/2	H P
90 mm	3	H P
110 mm	4	H P
140 mm	5	H P
160 mm	6	H P
180 mm	7	H P
200 mm	8	H P

Threaded End Cap



Size in MM	inch	Grade
20 mm	1/2	H T
25 mm	3/4	H T
32 mm	1	H T
40 mm	1 1/4	H T
50 mm	1 1/2	H T
63 mm	2	H T
75 mm	2 1/2	H T
90 mm	3	H T
110 mm	4	H T
140 mm	5	H T
160 mm	6	H T

End Cap



Size in MM	inch	Grade
63mm	2	LW P
75mm	2 1/2	LW P
90mm	3	LW P
110 mm	4	LW P
140 mm	5	LW P
160 mm	6	LW P
180 mm	7	LW P
200 mm	8	LW P

Reducer



Size in MM	inch	Grade
25x20	3/4x1/2	H P
32x20	1x1/2	H P
32x25	1x3/4	H P
40x20	1 1/4x1/2	H P
40x25	1 1/4x3/4	H P
40x32	1 1/4x1	H P
50x20	1 1/2x1/2	H P
50x25	1 1/2x3/4	H P
50x32	1 1/2x1	H P
50x40	1 1/2x1 1/4	H P
63x20	2x1/2	H P
63x25	2x3/4	H P
63x32	2x1	H P
63x40	2x1 1/4	H P
63x50	2x1 1/2	H P

Tail Piece



Size in MM	inch	Grade
63 mm	2	H P
75 mm	2 1/2	H P
90 mm	3	H P
110 mm	4	H P
140 mm	5	H P

Saddle Washer

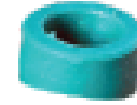

Size in MM	inch	Grade
50	1 1/2	
63x75	2x2 1/2	
90x110	3x4	
140x160	5x6	

Reducer



Size in MM	inch	Grade
75x40	2 1/2x1 1/4	H P
75x50	2 1/2x1 1/2	H P
75x63	2 1/2x2	H P
90x40	3x1 1/4	H P
90x50	3x1 1/2	H P
90x63	3x2	H P
90x75	3x2 1/2	H P
110x50	4x1 1/2	H P
110x63	4x2	H P
110x75	4x2 1/2	H P
110x90	4x3	H P

Reducer



Size in MM	inch	Grade
140x63	5x2	H P
140x75	5x2 1/2	H P
140x90	5x3	H P
140x110	5x4	H P
160x75	6x2 1/2	H P
160x90	6x3	H P
160x110	6x4	H P
160x140	6x5	H P

Reducer



Size in MM	inch	Grade
180x110	7x4	H P
180x140	7x5	H P
180x160	7x6	H P
200x110	8x4	H P
200x140	8x5	H P
200x160	8x6	H P



Reducer PN 16



Size in MM	inch	Grade
32x25	1x3/4	Pn16 P
50x40	1 1/2x1 1/4	Pn16 P
63x50	2x1 1/2	Pn16 P

RFTA



Size in MM	inch	Grade
25x20	3/4x1/2	H T
32x20	1x1/2	H T
32x25	1x3/4	H T
40x25	1 1/4x3/4	H T
40x32	1 1/4x1	H T
50x32	1 1/2x1	H T
50x40	1 1/2x1 1/4	H T
63x50	2x 1 1/2	H T

RFTA



Size in MM	inch	Grade
75x63	2 1/2x2	H T
90x63	3x2	H T
90x75	3x2 1/2	H T
110x50	4x 1 1/2	H T
110x63	4x2	H T
110x75	4x2 1/2	H T
110x90	4x3	H T

RFTA



Size in MM	inch	Grade
140x110	5x4	H T
160x140	6x5	H T

RFTA Heavy



Size in MM	inch	Grade
63x50	2x 1 1/2	H T xP

Reducing Bush



Size in MM	inch	Grade
25x20	3/4x1/2	H P
32x20	1x1/2	H P
32x25	1x3/4	H P
40x25	1 1/4x3/4	H P
40x32	1 1/4x1	H P
50x25	1 1/2x3/4	H P
50x32	1 1/2x1	H P
50x40	1 1/2x1 1/4	H P
63x32	2x1	H P
63x40	2x1 1/4	H P
63x50	2x1 1/2	H P

Reducing Bush



Size in MM	inch	Grade
75x40	2 1/2x1 1/4	H P
75x50	2 1/2x1 1/2	H P
75x63	2 1/2x2	H P
90x50	3x1 1/2	H P
90x63	3x2	H P
90x75	3x2 1/2	H P
110x50	4x1 1/2	H P
110x63	4x2	H P
110x75	4x2 1/2	H P
110x90	4x3	H P

Reducing Bush



Size in MM	inch	Grade
140x110	5x4	H P
160x75	6x2 1/2	H P
160x90	6x3	H P
160x110	6x4	H P
160x140	6x5	H P

Reducing Threaded Elbow



Size in MM	inch	Grade
25x20	3/4x1/2	H T
32x20	1x1/2	H T
32x25	1x3/4	H T
40x32	1 1/4x1	H T
50x40	1 1/2x1 1/4	H T
75x63	2 1/2x2	H T
90x75	3x2 1/2	H T

Reducing Plain Elbow



Size in MM	inch	Grade
25x20	3/4x1/2	H P
32x20	1x1/2	H P
32x25	1x3/4	H P
40x20	1 1/4x1/2	H P
40x25	1 1/4x3/4	H P
40x32	1 1/4x1	H P

Reducing Threaded TEE



Size in MM	inch	Grade
25x20	3/4x1/2	H T
32x20	1x1/2	H T
32x25	1x3/4	H T
75x63	2 1/2x2	H T
90x75	3x2 1/2	H T

Reducing Plain Tee



Size in MM	inch	Grade
25x20	3/4x1/2	H T
32x20	1x1/2	H P
32x25	1x3/4	H P
40x20	1 1/4x1/2	H P
40x25	1 1/4x3/4	H P
40x32	1 1/4x1	H P
50x20	1 1/2x1/2	H P
50x25	1 1/2x3/4	H P
50x32	1 1/2x1	H P
50x40	1 1/2x1 1/4	H P
63x20	2x1/2	H P
63x25	2x3/4	H P
63x32	2x1	H P
63x40	2x1 1/4	H P
63x50	2x1 1/2	H P

Reducing Plain Tee



Size in MM	inch	Grade
75x20	2 1/2x1/2	H P
75x25	2 1/2x3/4	H P
75x32	2 1/2x1	H P
75x40	2 1/2x1 1/4	H P
75x50	2 1/2x1 1/2	H P
75x63	2 1/2x2	H P
90x32	3x1	H P
90x40	3x1 1/4	H P
90x63	3x2	H P
90x75	3x2 1/2	H P
110x50	4x1 1/2	H P

Reducing Plain Tee



Size in MM	inch	Grade
110x63	4x2	H P
110x75	4x2 1/2	H P
110x90	4x3	H P
140x90	5x3	H P
140x110	5x4	H P
160x75	6x2 1/2	H P
160x90	6x3	H P
160x110	6x4	H P
160x140	6x5	H P
200x160	8x6	H P
200x180	8x7	H P

4 Way Reducing Tee



Size in MM	inch	Grade
32x20	1x1/2	H P
40x20	1 1/4x1/2	H P
40x25	1 1/4x3/4	H P
40x32	1 1/4x1	H P
50x20	1 1/2x1/2	H P
50x25	1 1/2x3/4	H P
50x32	1 1/2x1	H P
63x20	2x1/2	H P
63x25	2x3/4	H P
63x32	2x1	H P
63x40	2x1 1/4	H P
63x50	2x 1 1/2	H P

4 Way Reducing Tee



Size in MM	inch	Grade
75x20	2 1/2x1/2	H P
75x32	2 1/2x1	H P
75x40	2 1/2x1 1/4	H P
75x50	2 1/2x1 1/2	H P
75x63	2 1/2x2	H P
90x32	3x1	H P
90x40	3x1 1/4	H P
90x50	3x1 1/2	H P
110x90	4x3	H P

Reducer Heavy



Size in MM	inch	Grade
110x90	4x3	H P

Sweep Bend 90°



Size in MM	inch	Grade
25 mm	3/4	LW P
32 mm	1	LW P
40 mm	1 1/4	LW P
50 mm	1 1/2	LW P
63 mm	2	LW P
75 mm	2 1/2	LW P
90 mm	3	LW P
110 mm	4	LW P

Long Bend (Mould)



Size in MM	inch	Grade
63 mm	2	H P
110 mm	4	H P

RMTA



Size in MM	inch	Grade
25x20	3/4x1/2	H
32x25	1x3/4	H
75x63	2 1/2x2	H
90x63	3x2	H
90x75	3x2 1/2	H
110x90	4x3	H

Repair Service Saddle



Size in MM	inch	Grade
63 mm	2	H P
75 mm	2 1/2	H P
90 mm	3	H P
110 mm	4	H P
140 mm	5	H P
160 mm	6	H P

Tank Connector Union Type



Size in MM	inch	SCH 80
25 mm	1	
32 mm	1 1/4	
40 mm	1 1/2	
50 mm	2	
65 mm	2 1/2	

Tank Connector



Size in MM	inch	Grade
25 mm	3/4	H T
32 mm	1	H T
40 mm	1 1/4	H T
50 mm	1 1/2	H T
63 mm	2	H T

Threaded Tee Brass



Size in MM	inch	Grade
25x20	3/4x1/2	LW TxP
25 x 20	3/4x1/2	Heavy TxP
32 x 20	1x1/2	Heavy TxP

Threaded RFTA Brass



Size in MM	inch	Grade
25x20	3/4x1/2	LW TxP
25 x 20	3/4x1/2	Heavy TxP
32 x 20	1x1/2	Heavy TxP

Threaded Elbow Brass



Size in MM	inch	Grade
25x20	3/4x1/2	LW TxP
25 x 20	3/4x1/2	Heavy TxP
32 x 20	1x1/2	Heavy TxP

4 Way Tee



Size in MM	inch	Grade
50 mm	1 1/2	LW P
63 mm	2	LW P
75 mm	2 1/2	LW P

Line Trap



Size in MM	inch	Grade
50 mm	1 1/2	LW P
63 mm	2	LW P

Tail Flange



Size in MM	inch	Grade
90 mm	3	H

BoreWell End Cap



Size in MM	inch	Grade
140 mm	5	H P
160 mm	6	H P
180 mm	7	H P
200 mm	8	H P

Bend 45° PN 16



Size in MM	inch	Grade
25 mm	3/4	Pn16 P
32 mm	1	Pn16 P
40 mm	1 1/4	Pn16 P
50 mm	1 1/2	Pn16 P
63 mm	2	Pn16 P
110 mm	4	Pn16 P

Gully Trap



Size in MM	inch	Grade
160 x 110	6x4	H P



Bend 45°
Socket Type



Size in MM	inch	Grade
20 mm	1/2	LW P
25 mm	3/4	LW P
32 mm	1	LW P
40 mm	1 1/4	LW P
50 mm	1 1/2	LW P
63 mm	2	LW P
75 mm	2 1/2	LW P
90 mm	3	LW P
110 mm	4	LW P
140 mm	5	LW P
160 mm	6	LW P

Service
Saddle



Size in MM	Tin	Grade
40x20	1 1/4x1/2	H
40x25	1 1/4x3/4	H
40x32	1 1/4x1	H
50x20	1 1/2x1/2	H
50x25	1 1/2x3/4	H
50x32	1 1/2x1	H
63x20	2x1/2	H
63x25	2x3/4	H
63x32	2x1	H
75x20	2 1/2x1/2	H
75x25	2 1/2x3/4	H
75x32	2 1/2x1	H
90x20	3x1/2	H
90x25	3x3/4	H
90x32	3x1	H
110x20	4x1/2	H
110x25	4x3/4	H
110x32	4x1	H
140x20	5x1/2	H
140x25	5x3/4	H
140x32	5x1	H
140x40	5x1 1/4	H
140x50	5x1 1/2	H
160x20	6x1/2	H
160x25	6x1 3/4	H
160x32	6x1	H

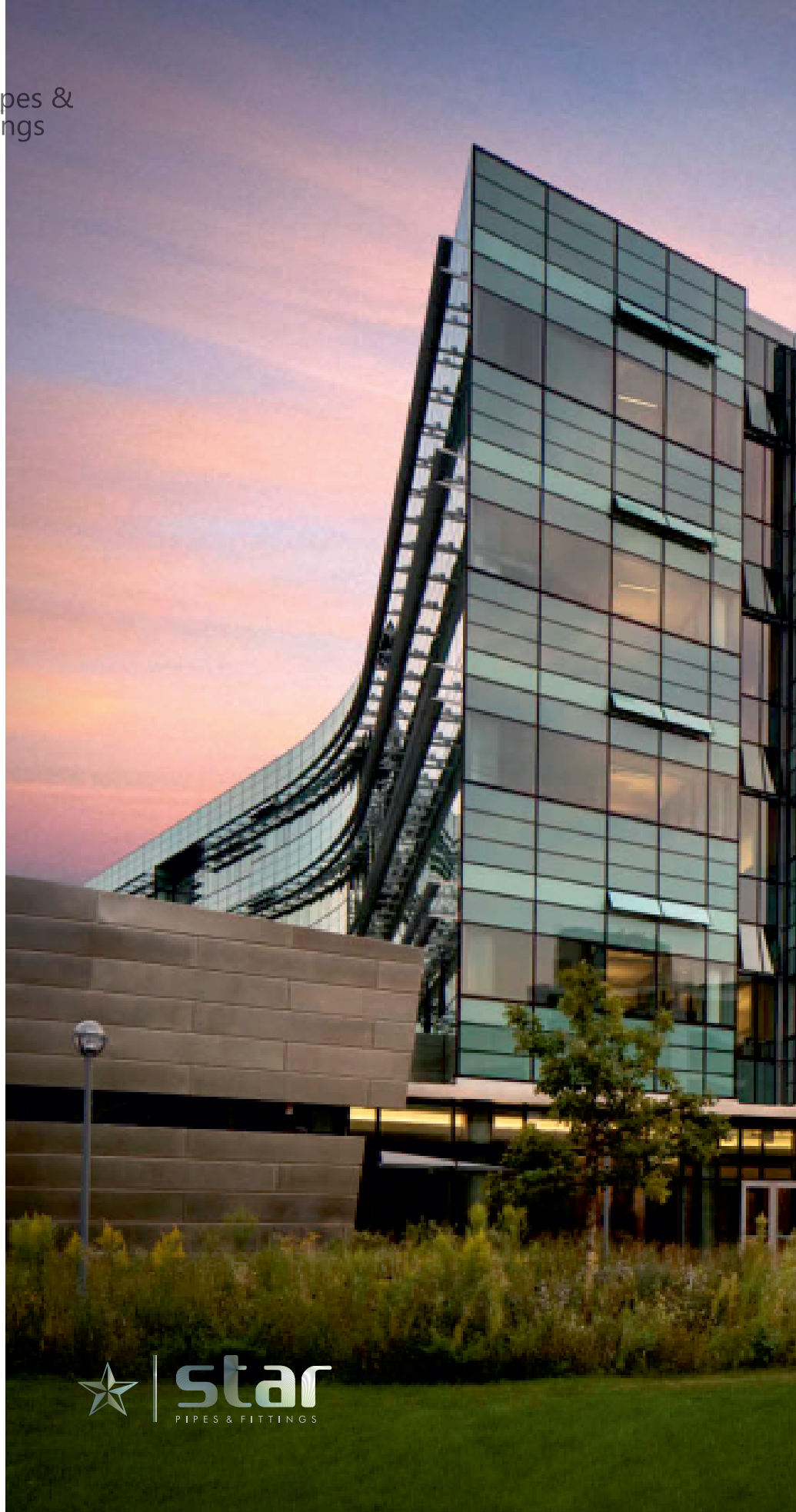

SWR Drainage System

IS-13592, 14735



Star SWR piping system is an effective solution for soil, waste and rainwater. They have various application in commercial and housing sectors with world class seals. Star SWR fittings ensures a leak proof joint and long lasting performance.

Elbow 87.5°



Size in MM	inch	Grade	
75 mm	2½	ISI	P
110 mm	4	ISI	P

Elbow 87.5°



Size in MM	inch	Grade	
75 mm	2½	ISI	R
90 mm	3	Heavy	R
110 mm	4	ISI	R
160 mm	6	Heavy	R

Elbow 87.5°



Size in MM	inch	Grade	
75 mm	2½	LW	P
90 mm	3	LW	P
110 mm	4	LW	P

Door Elbow 87.5°



Size in MM	inch	Grade	
75 mm	2½	ISI	P
110 mm	4	ISI	P

Door Elbow 87.5°



Size in MM	inch	Grade	
75 mm	2½	ISI	R
90 mm	3	Heavy	R
110 mm	4	ISI	R
160 mm	6	Heavy	R

Door Elbow 87.5°



Size in MM	inch	Grade	
75 mm	2½	LW	P
90 mm	3	LW	P
110 mm	4	LW	P

Tee Single 87.5°



Size in MM	inch	Grade	
75 mm	2½	ISI	P
110 mm	4	ISI	P



Tee Single 87.5°



Size in MM	inch	Grade	
75 mm	2½	ISI	R
90 mm	3	Heavy	R
110 mm	4	ISI	R
160 mm	6	Heavy	R

Tee Single 87.5°



Size in MM	inch	Grade	
75 mm	2½	LW	P
90 mm	3	LW	P
110 mm	4	LW	P

Door Tee Single 87.5°



Size in MM	inch	Grade	
75 mm	2½	ISI	P
110 mm	4	ISI	P

Door Tee Single 87.5°



Size in MM	inch	Grade	
75 mm	2½	ISI	R
90 mm	3	Heavy	R
110 mm	4	ISI	R
160 mm	6	Heavy	R

Door Tee Single 87.5°



Size in MM	inch	Grade	
75 mm	2½	LW	P
90 mm	3	LW	P
110 mm	4	LW	P

Door Tee Washer



Size in MM	inch
75 mm	2½
110 mm	4

Vent Cowl



Size in MM	inch	Grade	
40 mm	1¼	Heavy	P
50 mm	1½	Heavy	P
63 mm	2	Heavy	P
75 mm	2½	Heavy	P
90 mm	3	Heavy	P
110 mm	4	Heavy	P

Vent Cowl



Size in MM	inch	Grade	
63 mm	2	LW	P
110 mm	4	LW	P

Vent Cowl



Size in MM	inch	Grade	
63 x 50	2x1½	Heavy	P

Single Y



Size in MM	inch	Grade	
75 mm	2½	Heavy	R
90 mm	3	Heavy	R
110 mm	4	Heavy	R
160 mm	6	Heavy	R

Single Y



Size in MM	inch	Grade	
50 mm	1½	LW	P
63 mm	2	LW	P
75 mm	2½	LW	P
90 mm	3	LW	P
110 mm	4	ISI	P
140 mm	5	Heavy	P

Single Y Socket



Size in MM	inch	Grade	
50 mm	1½	LW	P

Single Y With Door



Size in MM	inch	Grade	
75 mm	2½	Heavy	R
90 mm	3	Heavy	R
110 mm	4	Heavy	R
160 mm	6	Heavy	R

Single Y With Door



Size in MM	inch	Grade	
63 mm	2	LW	P
75 mm	2½	LW	P
90 mm	3	LW	P
110 mm	4	LW	P
140 mm	5	Heavy	P

Cross Tee



Size in MM	inch	Grade	
75 mm	2½	Heavy	R
90 mm	3	Heavy	R
110 mm	4	Heavy	R

Cross Tee

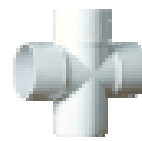

Size in MM	inch	Grade	
75 mm	2½	Heavy	P
90 mm	3	Heavy	P
110 mm	4	Heavy	P

Cross Tee With Door

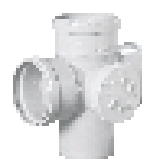

Size in MM	inch	Grade	
75 mm	2½	Heavy	R
90 mm	3	Heavy	R
110 mm	4	Heavy	R

Cross Tee With Door



Size in MM	inch	Grade	
75 mm	2½	Heavy	P
90 mm	3	Heavy	P
110 mm	4	Heavy	P

Double Y



Size in MM	inch	Grade	
75 mm	2½	Heavy	R
90 mm	3	Heavy	R
110 mm	4	Heavy	R

Double Y



Size in MM	inch	Grade	
75 mm	2½	Heavy	P
90 mm	3	LW	P
110 mm	4	Heavy	P

Double Y With Door

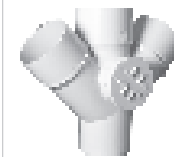

Size in MM	inch	Grade	
75 mm	2½	Heavy	R
90 mm	3	Heavy	R
110 mm	4	Heavy	R

Double Y With Door



Size in MM	inch	Grade	
75 mm	2½	Heavy	P
90 mm	3	LW	P
110 mm	4	Heavy	P

Reducer SWR



Size in MM	inch	Grade	
110 x 75	4x2½	LW	R
110 x 63	4x2	LW	P
110 x 75	4x2½	LW	P

Cleansing Pipe With Door



Size in MM	inch	Grade	
75 mm	2½	Heavy	R
90 mm	3	Heavy	R
110 mm	4	Heavy	R

Cleansing Pipe With Door



Size in MM	inch	Grade	
75 mm	2½	Heavy	P
90 mm	3	Heavy	P
110 mm	4	Heavy	P

Door Cap



Size in MM	inch	Grade	
40 mm	1¼	Heavy	T
50 mm	1½	Heavy	T
63 mm	2	Heavy	T
75 mm	2½	Heavy	T
90 mm	3	Heavy	T
110 mm	4	Heavy	T

Nahani Trap



Size in MM	inch	Grade	
110 x 63	4x2	H	P
110 x 75	4x2½	H	P
110 x 90	4x3	H	P

Nahani Trap



Size in MM	inch	Grade		
110 x 63	4x2	LW	P	45 W Jally
110 x 63	4x2	LW	P	45 W/O Jally
110x75	4x2½	LW	P	40 W Jally
110x75	4x2½	LW	P	40 W/O Jally
110 x 90	4x3	LW	P	35 W Jally
110 x 90	4x3	LW	P	35 W/O Jally

P Trap



Size in MM	inch	Grade	
110 mm	4	Heavy	P

Q Trap



Size in MM	inch	Grade	
110 mm	4	Heavy	P

S Trap



Size in MM	inch	Grade	
110 mm	4	Heavy	P

Reducing Y



Size in MM	inch	Grade	
110 x 75	4x2½	LW	R
75x 63	2½x2	LW	P
110 x 63	4x2	LW	P
110 x 75	4x2½	LW	P

Square Jali



Size in MM	inch	Grade	
110 mm	4		P

Round Jali



Size in MM	inch	Grade	
110 mm	4		P

Pipe Clip



Size in MM	inch	Grade	
25 mm	¾	LW	P
32 mm	1	LW	P



Size in MM	inch	Grade	
25 mm	¾	LW	P
32 mm	1	LW	P

Projection Clamp



Size in MM	inch	Grade	
25 mm	¾	LW	P
32 mm	1	LW	P
40 mm	1¼	LW	P
50 mm	1½	LW	P
63 mm	2	LW	P
75 mm	2½	LW	P
90 mm	3	LW	P
110 mm	4	LW	P

SWR Coupler



Size in MM	inch	Grade	
75 mm	2½	LW	R
110 mm	4	LW	R

Size in MM	inch	Grade	
75 mm	2½	LW	P
110 mm	4	LW	P

Reducing Door Y O Ring



Size in MM	inch	Grade	
110 x 75	4x2½	LW	R

Straight WC Connector



Size in MM	inch	Grade	
125x110	5x4	LW	P

Reducing Door Tee



Size in MM	inch	Grade	
110 x 75	4x2½	LW	RXR
110 x 75	4x2½	LW	RXP

P Trap Base



Size in MM	inch	Grade	
110 mm	4	Heavy	P

Reducing Tee



Size in MM	inch	Grade	
110 x 75	4x2½	LW	R
110 x 75	4x2½	LW	P

Oneway Trap



Size in MM	inch	Grade	
110x63&75	4	With Jali	
110x63&75	4	Without Jali	

Multi Floor Trap



Size in MM	inch	Grade	
3"-110x63	3x2	LW	P
4"-110x63&75	4x2, 2½	Heavy	P
7"-110x63&75	7x2, 2½	Heavy	P

Multi Floor Trap Without Jali

Size in MM	inch	Grade	
3"-110x63	4x2½	Heavy	P
4"-110x63&75	4x2, 2½	Heavy	p
7"-110x63&75	7x2, 2½	Heavy	P

Bends 45°



Size in MM	inch	Grade	
75 mm	2½	Heavy	R
90 mm	3	Heavy	R
110 mm	4	Heavy	R

Bends 45°



Size in MM	inch	Grade	
63 mm	2	LW	P
75 mm	2½	LW	P
90 mm	3	LW	P
110 mm	4	ISI	P

Pan Connector Straight



Size in MM	inch	Grade	
18 mm			

Pan Connector Offset



Size in MM	inch	Grade	
18 mm			
40 mm			



Installation of STAR Ringfit PVC Pipes

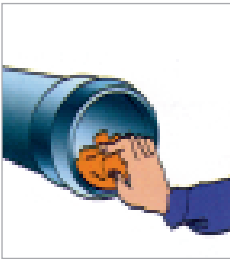

1. Clean the profile ring, the inside of the socket and the groove for the ring



2. Wet the profile ring with clean water. Squeeze it into a heart shape, then let it shape into the groove and check alignment



3. The pipe ends provided with a 150 factory made chamfer, must be cleaned and coated with lubricant before pushing into the socket. Mark insertion depth if not already provided.

4. Push together only up to the insertion mark to take care of expansion. For large diameter pipes, a pipe jack may be used

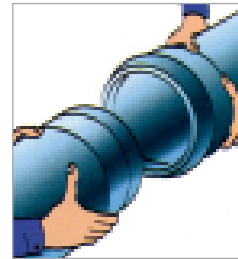

5. If shorter lengths are required, cut off the pipe ends squarely using fine-toothed saw and miter box.

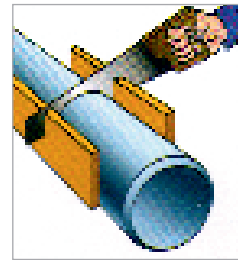

6. Prior to insertion in the socket the cut-off pipe must be deburred and chamfered approx 150, using a file or chamfering tool

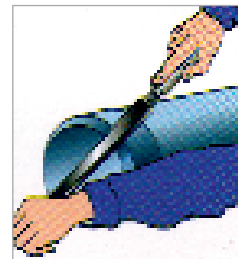

SWR Drainage Installation Method

Double pipe system

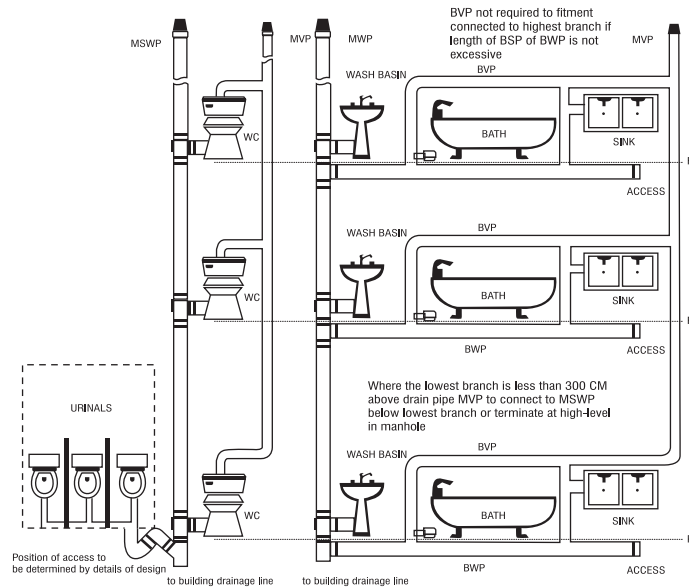

Single pipe system

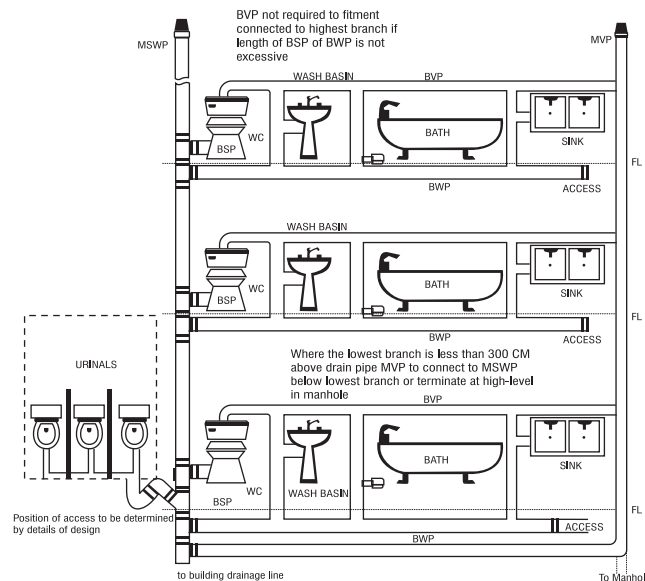

MWP - Main Waste Pipe
MVP - Main Vent Pipe

MSWP - Main Soil Waste Pipe
BVP - Branch Vent Pipe
BWP - Branch Waster Pipe

BSP - Branch Soile Pipe
WC - Water Closet

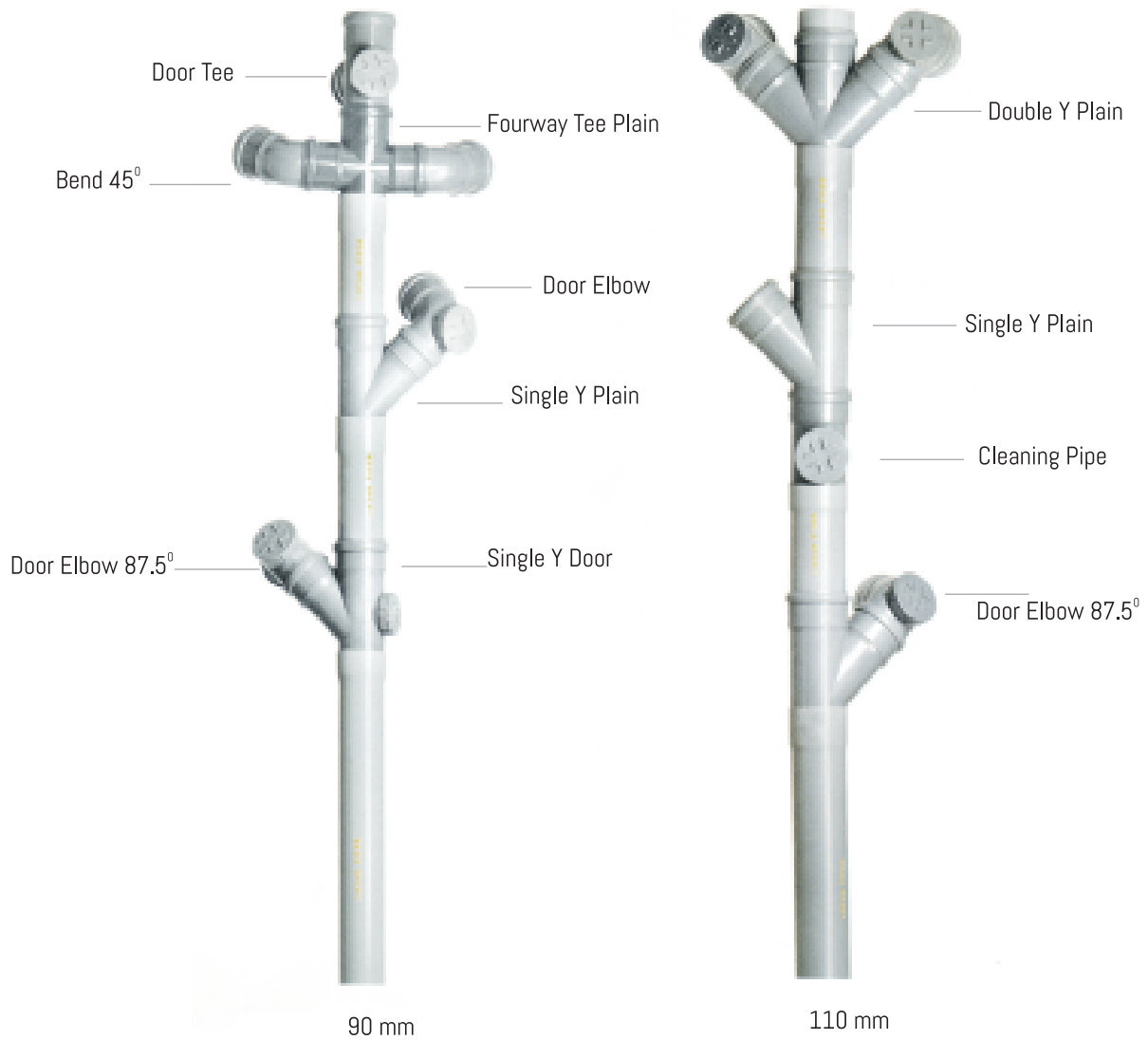

Typical Sanitation System

Underground Drainage Fittings

Inspection Chamber

- 315 x 110 - One Way
- Two Way Left/Right
- 3 Way Left/Right
- Bend
- Riser

THE SYSTEM

Star Underground drainage and sewerage system has been specially developed around the concept of promoting healthy and hygienic way of life by keeping the premises clean and neat. In order to avoid the offensive smell and unpleasant sight of human waste, the drainage system should be hidden from the view and should be able to withstand the ravages of time and weather. Hence it goes without saying that it should be of superior quality and should be able to function year after year without leakage or defects. It should ensure trouble free performance and durability that is where star comes in.



3 Way With Riser



2 Way With Riser



Bend With Riser



1 Way

Top Cover



Size in MM	inch
315 mm	12

2 Way Left & Right

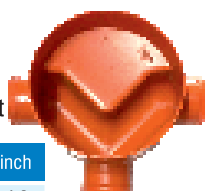

Size in MM	inch
315 mm	12

Riser



Size in MM	inch
315 mm	12

2 Way Left

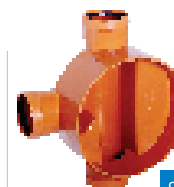

Size in MM	inch
315 mm	12

Base 1 Way Straight



Size in MM	inch
315 mm	12

3 Way Left & Right



Size in MM	inch
315 mm	12

Bend



Size in MM	inch
315 mm	12

2 Way Right

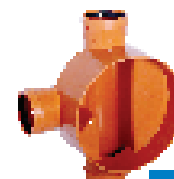

Size in MM	inch
315 mm	12



Rain Water Harvester

Half Round Centre Drop

Size in MM	inch
160 x 110	6x4
160 x 63	6x2
160 x 75	6x2½



Half Round End Drop

Size in MM	inch
160 x 110	6x4
160 x 63	6x2
160 x 75	6x2½



Half Round Elbow Drop

Size in MM	inch
160x110	6x4
160x75	6x2½
160x63	6x2



Half Round Elbow

Size in MM	inch
160 mm	6



Half Round End Cap

Size in MM	inch
160 mm	6

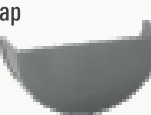

Half Round Coupler

Size in MM	inch
160mm	6



Star Bond - Heavy duty PVC Adhesive with dauber

These high quality PVC adhesive are specially formulated to withstand the rigours of various climatic conditions. ideal for high-rise buildings, apartment complexes and commercial buildings



Star Bond
CPVC
Solvent

Size in MM	inch
20 ml	Tube
29.5 ml	Tube
50 ml	Tube
50 ml	Tin
118 ml	Tin
237 ml	Tin



Star Bond

Size in MM	Tin
50 ml	Tin
100 ml	Tin
250 ml	Tin
500 ml	Tin
1 ltr	Tin
5 ltr	Tin
50 Ltr	Tin

Solvent Cement
Normal



Size in MM	P bottle
25 ml	Bottle
50 ml	Bottle
100 ml	Bottle
250 ml	Bottle
500 ml	Bottle
1 Ltr	Bottle
5 Ltr	Bottle
30 Ltr	
50 Ltr	
180 Ltr	



Star Bond
uPVC Solvent

Size in MM	inch
50 ml	Tin
100 ml	Tin
1Ltr	Can
5Ltr	Can

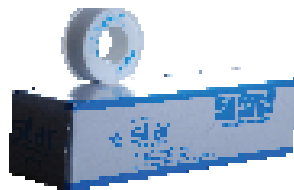

star
P.T.F.E. Thread
Seal Tape

Item	Specification
P.T.F.E. Tape	12 mm x 0.075 mm x 10 mtr

SILICONE SEALANTS & PU FOAM

Item	Grade
GP Silver	3400
GP Gold	3600
Neutral	N7400
Glass & Aquarium	
Weather Sealant	W7800



ROTO TANK - ISI

CAPACITY		STD SIZE IN mm		
In Ltrs	Length	Height	Manhole Dia	
500	840	970	420	
750	960	1150	420	
1000	1050	1250	420	



star
WATER TANKS

CONVENIENT
SAFE
DURABLE



STAR HIGH QUALITY WATER TANK
IS 4984 : 1995

IS 4984:1995



CM/L 6200063389



STAR - LD 3 LAYER WHITE, LD 2 LAYER BLACK

CAPACITY		STD SIZE IN mm		
In Ltrs	Diameter	Height	Manhole Dia	
500	830	1100	375	
750	950	1200	375	
1000	1050	1350	375	
1500	1220	1500	375	
2000	1300	1750	375	



STAR DOVE-3 LAYER WHITE, 2 LAYER BLACK, 2 LAYER BLUE



CAPACITY		STD Size in mm		
In Ltrs	Diameter	Height	Manhole Dia	
500	864	965	450	
750	1041	1067	450	
1000	1118	1220	450	
1500	1220	1372	450	
2000	1346	1525	450	
3000	1525	1905	450	
5000	1905	2160	450	

CAPSULE TANK - LD 2 LAYER WHITE

CAPACITY		STD Size in mm		
In Ltrs	Diameter	Height	Manhole Dia	
1000	900	1500	375	

DIANA 3 LAYER WHITE, LD 2 LAYER BLACK

CAPACITY		STD Size in mm		
In Ltrs	Diameter	Height	Manhole Dia	
500	830	1100	375	
750	950	1200	375	
1000	1050	1350	375	



STAR MACHO -3 LAYER WHITE, 3 LAYER BLACK, 3 LAYER BLUE



CAPACITY		STD Size in mm		
In Ltrs	Diameter	Height	Manhole Dia	
500	910	940	400	
750	960	1060	400	
1000	1020	1250	400	

LOFT TANK

CAPACITY		STD SIZE IN mm		
In Ltrs	Length	Height	Manhole Dia	
200	950	700	430	



UNDERGROUND WATER TANK





CAPACITY		STD Size in mm		
In Ltrs	Diameter	Height	Manhole Dia	
1000	1110	1270	400	
2000	1384	1804	400	





starpaulin

STRENGTH YOU CAN TRUST, FOR AGES.

-  UV Stabilized
-  Light Weight and Durable
-  100% Leak Proof
-  Highly Flexible
-  Ultrasonic Eyeletting

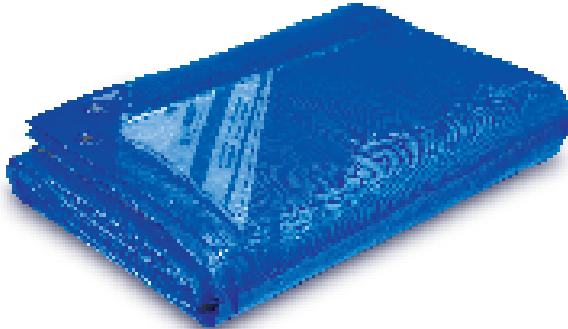

STAR FLEX

ID IN MM	Nearest Inch Equiv	Standard Length in Mtr.
20	¾"	30
25	1"	30
30	1 ¼"	30
38	1 ½"	30
50	2"	30
65	2 ½"	30
75	3"	30
100	4"	30



Sr. No.	Starpaulin		STARPAULIN ROLL	
	Cut Size	Finish Size	70 GSM 50 MTRS	120 GSM 50 MTRS
1	6'x6'	5'.5"x5'.3"		
2	9'x6'	8'.5"x5'.3"		
3	9'x9'	8'.5"x8'.3"	4.5'	4.5'
4	12'x6'	11'.5"x5'.3"	6'	6'
5	12'x9'	11'.5"x8'.3"	9'	9'
6	12'x12'	11'.5"x11'.1"	12'	12'
7	15'x9'	14'.5"x8'.3"	18'	18'
8	15'x12'	14'.5"x11'.1"	24'	24'
9	15'x15'	14'.5"x13'.11"	36'	30'
10	18'x12'	17'.5"x11'.1"		36'
11	18'x15'	17'.5"x11'.11"		42'
12	21'x9'	20'.5"x8'.3"		48'
13	21'x12'	20'.5"x11'.1"	4.5'	
14	21'x15'	20'.5"x13'.11"	6'	
15	21'x18'	20'.5"x16'.11"	9'	
16	24'x12'	23'.5"x11'.1"	12'	4.5'
17	24'x15'	23'.5"x13'.1"	18'	9'
18	24'x18'	23'.5"x16'.11"	24'	12'
19	24'x21'	23'.5"x19'.9"	36'	18'
20	27'x12'	26'.5"x11'.1"		24'
21	27'x15'	26'.5"x13'.11"		30'
22	27'x18'	26'.5"x16'.11"		36'
23	27'x21'	26'.5"x19'.9"		42'
24	27'x24'	26'.5"x22'.7"	4.5'	48'
25	30'x18'	29'.5"x16'.11"	9'	
26	30'x21'	29'.5"x19'.9"	12'	
27	30'x24'	29'.5"x22'.7"	18'	
28	30'x27'	29'.5"x25'.7"	24'	
29	30'x30'	29'.5"x28'.5"	30'	
30	33'x27'	32'.5"x25'.7"	36'	
31	36'x18'	35'.5"x16'.11"	42'	
32	36'x21'	35'.5"x19'.9"	48'	
33	36'x24'	35'.5"x22'.7"		
34	36'x30'	35'.5"x28'.5"		
35	40'x30'	39'.5"x28'.5"	4.5'	
36	40'x36'	39'.5"x34'.3"	9'	
37	40'x40'	39'.5"x38'.1"	12'	
38	45'x30'	44'.5"x28'.5"	18'	
39	45'x36'	44'.5"x34'.3"	24'	
40	45'x40'	44'.5"x38'.1"	36'	
41	45'x45'	44'.5"x42'.11"		
42	50'x50'	49'.5"x47'.7"		
43	60'x40'	59'.5" x 38'.1"		
44	60'x60'	59'.5" x 57'.3"		

STAR FLEX GARDEN HOSE

Mfrs. and Exporters of Suction and Delivery Hose

QUALITY IN EVERY LENGTH

Garden Hose: ½", ¾", 1"





GREEN COLOUR SUCTION AND DELIVERY HOSES

The hoses shall be as uniform as commercially practicable in colour, Opacity and other physical properties. They shall consist of a flexible thermoplastics material supported in its mass by a helix of thermoplastic material of similar molecular structure. The reinforcing and flexible components of the wall shall be fused and free from visible cracks, porosity, foreign inclusions or other defects such as are liable to cause failure of these hoses in service.



PRODUCT SPECIFICATIONS

Nominal Size		Diameter		Bending Radius	Pressure (at 30°)		Standard Lengths
Inches	mm	ID mm	OD mm		Working Kg/²	Bursting Kg/²	
¾"	20	19.0 ± 0.5	21.0 ± 1.0	45	7.0	24.0	30
1"	25	25.0 ± 0.5	27.5 ± 1.0	55	7.0	23.0	30
1¼"	30	30.0 ± 0.5	33.2 ± 1.0	75	6.5	20.0	30
1½"	38	38.0 ± 0.5	40.9 ± 1.0	95	5.0	16.0	30
2"	50	50.0 ± 0.5	53.7 ± 1.5	122	4.0	16.0	30
2½"	65	63.0 ± 1.0	66.9 ± 1.5	160	4.0	16.0	30
3"	75	75.0 ± 1.0	79.1 ± 1.5	272	3.5	15.0	30
4"	100	100.0 ± 1.0	105.7 ± 2.0	290	3.5	11.0	30

Recommended maximum working temperature: 60° / 70°C

APPLICATION

Suction hose is excellent for all types of water distribution and comes as a boon for irrigation in the agricultural sector. It is excellent for conveying granules & fine particles of raw materials in processing industry. It has a rigid PVC spiral reinforcement between soft walls which makes it an ideal substitute for rubber hoses. It is light in weight and extremely flexible. It can be put to task even in the most demanding curves & bends with absolutely no loss of flexibility. Smooth inside and outside it has excellent resistance to pressure, external impacts, most of the chemicals, gases, light acids and saline water.



star
P I P E S



star
P I P E S

STAR PIPES ISI

Class 6 12.5 kg/cm ²	: 20mm to 250 mm	(½" to 10")
Class 5 10 kg/cm ²	: 20mm to 250 mm	(½" to 10")
Class 4 8 kg/cm ²	: 25mm to 250 mm	(¾" to 10")
Class 3 6 kg/cm ²	: 40mm to 315 mm	(1¼" to 12")
Class 2 4 kg/cm ²	: 63mm to 315 mm	(2" to 12")
Class 1 2.5 kg/cm ²	: 90mm to 315 mm	(3" to 12")

STAR ISI PLUMBING PIPES AS PER IS: 4985

20mm to 50 mm (½" to 1½")

STAR PLUMBING (15kg Non ISI PIPES)

20mm to 50 mm (½" to 1½")

STAR PIPES - NON ISI

Class 6 12.5 kg/cm ²	: 20mm to 250 mm	(½" to 10")
Class 5 10 kg/cm ²	: 20mm to 250 mm	(½" to 10")
Class 4 8 kg/cm ²	: 25mm to 250 mm	(¾" to 10")
Class 3 6 kg/cm ²	: 40mm to 315 mm	(1¼" to 12")
Class 2 4 kg/cm ²	: 63mm to 315 mm	(2" to 12")
Class 1 2.5 kg/cm ²	: 90mm to 315 mm	(3" to 12")
Threaded Pipes	: 20mm to 63 mm	(½" to 2")
Drainage Pipes	: 50mm to 160 mm	(1½" to 6")

110mm 4 Kg/Cm² BLUE STAR EASY FLOW

STAR - HARVESTER - HALF ROUND PVC PIPES

4Kg /cm ²	: 110mm to 200 mm	(4" to 8")
2.5Kg /cm ²	: 110mm to 200 mm	(4" to 8")
Drainage	: 110mm to 160 mm	(4" to 6")

STAR GOLD UPVC WHITE COLOUR ASTM D-1785 PLAIN ENDED PIPES (LEAD FREE)

schedule 40	: 15mm to 100 mm	(½" to 4")
schedule 80	: 15mm to 100 mm	(½" to 4")

STAR ASTM BLUE COLOUR THREADED PIPES 1785 D-THREADED

schedule 40	: 15mm to 50 mm	(½" to 2")
schedule 80	: 15mm to 50 mm	(½" to 2")

STAR SWR PIPES - IS : 13592 GROOVED JOINT ('O' RING)

Type 'A'	: 75mm to 160 mm	(2½" to 6")
Type 'B'	: 75mm to 160 mm	(2½" to 6")

STAR SWR PIPES - IS : 13592 SOLVENT CEMENT JOINT

Type 'A'	: 75mm to 160 mm	(2½" to 6")
Type 'B'	: 75mm to 160 mm	(2½" to 6")

MACHO

10 kg/cm ²	: 20mm to 32 mm	(½" to 1")
6 kg/cm ²	: 40mm to 50 mm	(1¼" to 1½")
4 kg/cm ²	: 63mm to 110 mm	(2" to 4")
Drainage	: 140mm to 200 mm	(5" to 8")

MACHO HARVESTER - HALF ROUND PVC PIPES

140mm to 200 mm (5" to 8")



STAR BENDS & SPECIALS

STAR PREMIUM (Made of STAR ISI Pipes)

4 Kg	: 63 mm to 250 mm
6 Kg	: 40 mm to 200 mm
8 Kg	: 25 mm to 200 mm
10 Kg	: 20 mm to 200 mm
12.5 Kg	: 20 mm to 200 mm

STAR PREMIUM SWAN NECK

3"	4 Kg	: 63 mm to 200 mm
	6 Kg	: 40 mm to 200 mm
	8 Kg	: 25 mm to 200 mm
	10 Kg	: 20 mm to 200 mm
	12.5 Kg	: 20 mm to 200 mm

6"	4 Kg	: 63 mm to 200 mm
	6 Kg	: 40 mm to 200 mm
	8 Kg	: 25 mm to 200 mm
	10 Kg	: 20 mm to 200 mm
	12.5 Kg	: 20 mm to 200 mm

9"	4 Kg	: 63 mm to 200 mm
	6 Kg	: 40 mm to 200 mm
	8 Kg	: 25 mm to 200 mm
	10 Kg	: 20 mm to 200 mm
	12.5 Kg	: 20 mm to 200 mm



STAR BEND

4 Kg	: 63 mm to 250 mm
6 Kg	: 40 mm to 200 mm
8 Kg	: 25 mm to 200 mm
10 Kg	: 20 mm to 200 mm
12.5 Kg	: 20 mm to 200 mm

MACHO BEND

4 Kg	: 63 mm to 110 mm
6 Kg	: 40 mm to 50 mm
10 Kg	: 20 mm to 32 mm

High Quality means durability.



STAR BOND BALL VALVE PASTED

Size in mm	Size in Inch
20	1/2"
25	3/4"
32	1"
40	1 1/4"
50	1 1/2"
63	2"

STAR BOND BALL VALVE THREADED

Size in mm	Size in Inch
20	1/2"
25	3/4"
32	1"
40	1 1/4"
50	1 1/2"
63	2"



STAR footvalve

Size	Std. Pack
1"	10
1 1/4"	5
1 1/2"	5
2"	5



STAR footvalve Grey

Size	Std. Pack
1"	10
1 1/4"	5
1 1/2"	5
2"	5



Luxury Flushing Cisterns

Luxury Flushing Cisterns

MODEL	DESCRIPTION
STAR DOVE	DUAL FLUSH
STAR LUXE	DUAL FLUSH
STAR ULTRA	SINGLE FLUSH
STAR ECO	SINGLE FLUSH

SPECIFICATIONS

- Twin Knob for 3x6/5 & 10 Litres of Flushing
- Dual Flushing System Prevent Water Wastage.
- An Ideal Product for hygienic toilet Combined with water saver too.

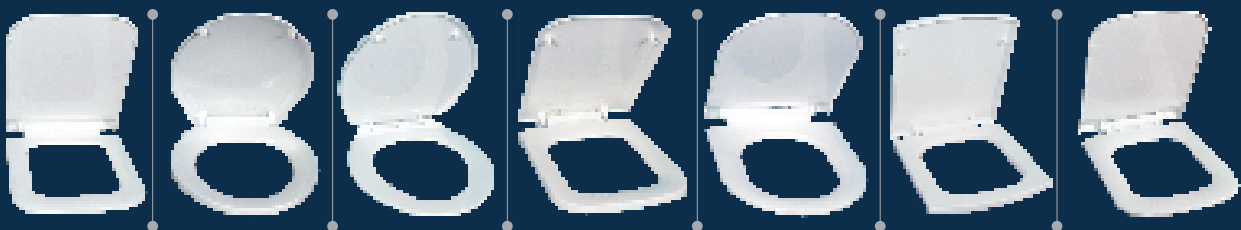



star
BATHWARE

EDGE
STYLE AND
STATUS



WARRANTY



10 YEARS
DEPENDABLE
WARRANTY

HAND
CRAFTED



THESE EXQUISITE
PIECES ARE REFINED
AND HAND-POLISHED
BY SKILLED ARTISANS.

SOFT TURN



SOFT MOVEMENT
OF ALL
SWIVEL SPOUTS
FOR EASY
HANDLING.

SOFT MOVE



SOFT HANDLING
FOR EFFORTLESS
PRECISION
AND ULTIMATE
COMFORT
FOR A LIFETIME

AQUA JOY



SAVE PRECIOUS
RESOURCES AND
ENJOY 100%
WATER COMFORT.

DIAMOND
FINISH









MADE-TO-LAST
SURFACES, SHINY
LIKE A DIAMOND.

ACUMEN SERIES

ADONIS SERIES

	 ACN-101 Pillar Cock	 ACN-111 Bib Cock with Wall Flange
	 ACN-135 Sink Cock with Bottom Swivel Spout	 ACN-113 Bib Cock Two Way with Wall Flange
	 ACN-131 Sink Cock with Swivel Spout (Wall Mounted)	 ACN-132 Sink Cock with Extended Swivel Spout (WM)
	 ACN-121 Angular Stop Cock with Wall Flange	 ACN-122 Angle cock 2 way with wall flange
 ACN-133 Sink Cock with Swivel Spout (Table Mounted)		

	 ADN-101 Pillar Cock	 ADN-111 Bib Cock with Wall Flange
	 ADN-113 Bib Cock Two Way with Wall Flange	 ADN-121 Angular Stop Cock with Wall Flange
	 ADN-102 Pillar Cock High Neck	 ADN-181 Single Lever Basin Mixer with 450mm Braided Hoses
	 ADN-182 Single Lever Basin Mixer with Extended body with 450mm braided hoses	
 ADN-131 Sink Cock with Swivel Spout (Wall Mounted)	 ADN-133 Sink Cock with Swivel Spout (Table Mounted)	 ADN-122 Angle cock 2 way with wall flange

 ACN-141 Wall Mixer with "L" Bend	 ACN-143 Wall Mixer 3 in 1
 ACN-142 Wall Mixer with Crutch	 ACN-134 Sink Cock with Extended Swivel Spout (TM)
 ACN-154 Exposed Parts Kit of Single Lever Concealed Diverter (Suitable For CB-105)	 ACN-155 Exposed Parts Kit of Single Lever Concealed High Flow Diverter (Suitable For CB-106)









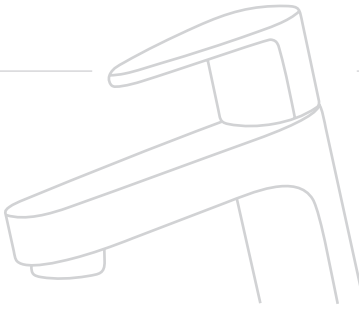











 ADN-141 Wall Mixer with "L" Bend	 ADN-143 Wall Mixer 3 in 1
 ADN-142 Wall Mixer with Crutch	 ADN-140 Wall Mixer Non Telephonic Shower Arrangement
 ADN-135 Sink Cock with Bottom Swivel Spout	 ADN-154 Exposed Parts Kit of Single Lever Concealed Diverter (Suitable For CB-105)

 ACN-150 15mm (CB-101) Concealed Stop Cock	 ACN-151 20mm (CB-102) Concealed Stop Cock	 ACN-152 (CB-103) Flush Cock H/T	 ACN-152B (CB-103B) Flush Cock Q/T
--	--	--	--

 ADN-150 15mm (CB-101) Concealed Stop Cock	 ADN-151 20mm (CB-102) Concealed Stop Cock	 ADN-152 (CB-103) Flush Cock H/T	 ADN-152B (CB-103B) Flush Cock Q/T
---	--	--	--

VERNA SERIES



		
VER-103 Pillar Cock With Extended Body	VER-101 Bib Cock Pillar Cock	VER-111 Bib Cock with Wall Flange
		
VER-113 Bib Cock Two Way with Wall Flange	VER-121 Angular Stop Cock with Wall Flange	
		
VER-105 Center Hole Basin Mixer with 450mm Braided Hoses	VER-132 Sink Cock with Extended Swivel Spout (WM)	VER-134 Sink Cock with Extended Swivel Spout (TM)
		
VER-131 Sink Cock with Swivel Spout (Wall Mounted)	VER-133 Sink Cock with Swivel Spout (Table Mounted)	VER-122 Angular Stop Cock Dual Handle
		
VER-141 Wall Mixer with "L" Bend	VER-143 Wall Mixer 3 in 1	
		
VER-142 Wall Mixer with Crutch	VER-140 Wall Mixer Non Telephonic Shower Arrangement	VER-136 Sink Mixer with Swivel Spout (WM)
		
VER-135 Sink Cock with Bottom Swivel Spout	VER-154 Exposed Parts Kit of Single Lever Concealed Diverter (Suitable For CB-105)	VER-155 Exposed Parts Kit of Single Lever Concealed High Flow Diverter (Suitable For CB-106)
		
VER-150 15mm (CB-101) Concealed Stop Cock	VER-151 20mm (CB-102) Concealed Stop Cock	VER-152 (CB-103) Flush Cock H/T
		VER-152B (CB-103B) Flush Cock Q/T

FRAGRANCE SERIES

		
FRG-103 Pillar Cock With Extended Body	FRG-101 Bib Cock Pillar Cock	FRG-111 Bib Cock with Wall Flange
		
FRG-113 Bib Cock Two Way with Wall Flange	FRG-121 Angular Stop Cock with Wall Flange	
		
FRG-181 Single Lever Basin Mixer With 450mm Braided Hoses	FRG-182 Single Lever Basin Mixer with extended body with 450mm Braided Hoses	FRG-122 Angular Stop Cock Dual Handle
		
FRG-131 Sink Cock with Swivel Spout (Wall Mounted)	FRG-133 Sink Cock with Swivel Spout (Table Mounted)	FRG-105 Center Hole Basin Mixer with 450mm Braided Hoses
		
FRG-141 Wall Mixer with "L" Bend	FRG-142 Wall Mixer with Crutch	FRG-143 Wall Mixer 3 in 1
		
FRG-140 Wall Mixer Non Telephonic Shower Arrangement	FRG-136 Sink Mixer with Swivel Spout (WM)	FRG-132 Sink Cock with Extended Swivel Spout (WM)
		
FRG-134 Sink Cock with Extended Swivel Spout (TM)		
		
FRG-135 Sink Cock with Bottom Swivel Spout	FRG-154 Exposed Parts Kit of Single Lever Concealed Diverter (Suitable For CB-105)	FRG-155 Exposed Parts Kit of Single Lever Concealed High Flow Diverter (Suitable For CB-106)
		
FRG-150 15mm (CB-101) Concealed Stop Cock	FRG-151 20mm (CB-102) Concealed Stop Cock	FRG-152 (CB-103) Flush Cock H/T
		FRG-152B (CB-103B) Flush Cock Q/T











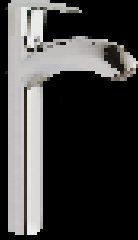

star
BATHWARE

CISCO SERIES





















PINNACLE SERIES

					
CIS-103 Pillar Cock With Extended Body	CIS-101 Pillar Cock	CIS-111 Bib Cock with Wall Flange	PIN-103 Pillar Cock with Extended Body	PIN-101 Pillar Cock	PIN-111 Bib Cock with Wall Flange
					
CIS-102 Pillar Cock High Neck	CIS-102L Pillar Cock High Neck Left	CIS-112 Long Body Bib Cock with Wall Flange	PIN-102 Pillar Cock High Neck	PIN-102L Pillar Cock High Neck Left	PIN-112 Long Body Bib Cock with Wall Flange
					
CIS-102L Pillar Cock High Neck Left	CIS-112 Long Body Bib Cock with Wall Flange	CIS-113B Bib Cock Two Way (DH)	PIN-102L Pillar Cock High Neck Left	PIN-112 Long Body Bib Cock with Wall Flange	PIN-113B Bib Cock Two Way (DH)
					
CIS-131 Sink Cock with Swivel Spout (Wall Mounted)	CIS-133 Sink Cock with Swivel Spout (Table Mounted)	CIS-122 Angular Stop Cock Dual Handle with Wall Flange	PIN-131 Sink Cock with Swivel Spout (Wall Mounted)	PIN-133 Sink Cock with Swivel Spout (Table Mounted)	PIN-122 Angular Stop Cock Dual Handle with Wall Flange
					
CIS-141 Wall Mixer with "L" Bend	CIS-142 Wall Mixer with Crutch	CIS-143 Wall Mixer 3 in 1	PIN-141 Wall Mixer with "L" Bend	PIN-142 Wall Mixer with Crutch	PIN-143 Wall Mixer 3 in 1
					
CIS-105 Center Hole Basin Mixer with 450mm Braided Hoses	CIS-140 Wall Mixer Non Telephonic Shower Arrangement	CIS-136 Sink Mixer with Swivel Spout (WM)	PIN-105 Center Hole Basin Mixer with 450mm Braided Hoses	PIN-140 Wall Mixer Non Telephonic Shower Arrangement	PIN-136 Sink Mixer with Swivel Spout (WM)
					
CIS-135 Sink Cock with Bottom Swivel Spout	CIS-154 Exposed Parts Kit of Single Lever Concealed Diverter (Suitable For CB-105)	CIS-155 Exposed Parts Kit of Single Lever Concealed High Flow Diverter (Suitable For CB-106)	PIN-135 Sink Cock with Bottom Swivel Spout	PIN-154 Exposed Parts Kit of Single Lever Concealed Diverter (Suitable For CB-105)	PIN-155 Exposed Parts Kit of Single Lever Concealed High Flow Diverter (Suitable For CB-106)
					
CIS-150 15mm (CB-101) Concealed Stop Cock	CIS-151 20mm (CB-102) Concealed Stop Cock	CIS-152 (CB-103) Flush Cock H/T	PIN-150 15mm (CB-101) Concealed Stop Cock	PIN-151 20mm (CB-102) Concealed Stop Cock	PIN-152 (CB-103) Flush Cock H/T
					
		CIS-152B (CB-103B) Flush Cock Q/T			PIN-152B (CB-103B) Flush Cock Q/T

ILLUSION SERIES

 ILN-101 Pillar Cock	 ILN-111 Bib Cock with Wall Flange	
 ILN-112 Long Body Bib Cock with Wall Flange	 ILN-113 Bib Cock Two Way with Wall Flange	
 ILN-102 Sink Cock with Casted Spout (TM)	 ILN-105 Center Hole Basin Mixer with 450mm Braided Hoses	 ILN-121 Angular Stop Cock with Wall Flange
 ILN-131 Sink Cock with 'J' Spout (WM)	 ILN-133 Sink Cock with 'J' Spout (TM)	 ILN-122 Angular Stop Cock Dual Handle with Wall Flange
 ILN-141 Wall Mixer with 'L' Bend	 ILN-143 Wall Mixer 3 in 1	
 ILN-142 Wall Mixer with Crutch	 ILN-140 Wall Mixer Non Telephonic Shower Arrangement	 ILN-136 Sink Mixer with Swivel Spout (WM)
 ILN-135 Sink Cock with Bottom Swivel Spout (Wall Mounted)	 ILN-132 Sink Cock with Extended Spout (WM)	 ILN-134 Sink Cock with Extended Spout (TM)
 ILN-150 15mm (CB-101) Concealed Stop Cock	 ILN-151 20mm (CB-102) Concealed Stop Cock	 ILN-152 (CB-103) Flush Cock H/T
		 ILN-152B (CB-103B) Flush Cock Q/T

CORAL SERIES

 CRN-101 Pillar Cock	 CRN-111 Bib Cock with Wall Flange	
 CRN-112 Long Body Bib Cock with Wall Flange	 CRN-113 Bib Cock Two Way With Cartridge	
 CRN-102 Sink Cock with Casted Spout (TM)	 CRN-105 Center Hole Basin Mixer with 450mm Braided Hoses	 CRN-121 Angular Stop Cock with Wall Flange
 CRN-131 Sink Cock with Swivel Spout (WM)	 CRN-133 Sink Cock with Swivel Spout (TM)	 CRN-122 Angular Stop Cock Dual Handle with Wall Flange
 CRN-141 Wall Mixer with 'L' Bend	 CRN-142 Wall Mixer 3 in 1	
 CRN-142 Wall Mixer with Crutch	 CRN-140 Wall Mixer Non Telephonic Shower Arrangement	 CRN-136 Sink Mixer with Casted Spout (WM)
 CRN-137 Sink Mixer with 'J' Spout (WM)	 CRN-130 Sink Cock with Casted Spout (WM)	 CRN-135 Sink Cock with Bottom Swivel Spout
 CRN-150 15mm (CB-101A) Concealed Stop Cock	 CRN-151 20mm (CB-102) Concealed Stop Cock	 CRN-152 (CB-103) Flush Cock H/T
		 CRN-152B (CB-103B) Flush Cock Q/T





star
BATHWARE

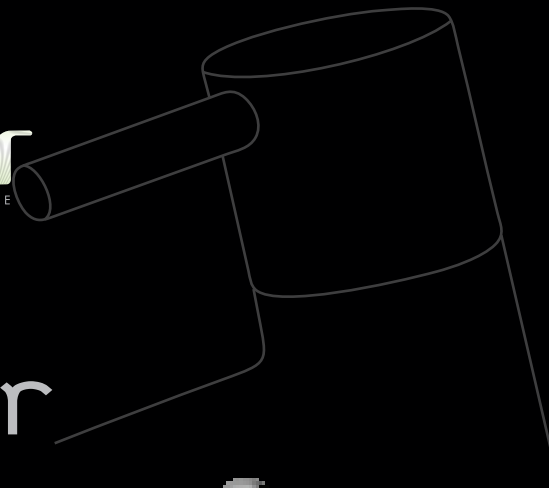

MIRACLE

Thar

 MIR-101 Pillar Cock	 MIR-102 Pillar Cock High Neck	 MIR-105 Center Hole Basin Mixer	
 MIR-111 Bib Cock with wall hung	 MIR-112 Long Body Bib Cock with wall hung	 MIR-113 Bib Cock Two Way	
 MIR-121 Angular stop Cock with wall hung	 MIR-122 Angular stop Cock Dual handle with wall hung	 MIR-131 Sink Cock with Swivel spout (WM)	
 MIR-132 Sink Cock with Extended Swivel spout (WM)	 MIR-133 Sink Cock with Swivel spout (TM)	 MIR-134 Sink Cock with extended Swivel spout (TM)	
 MIR-136 Sink Mixer with regular Swivel spout (WM)	 MIR-137 Sink Mixer with extended Swivel spout (WM)	 MIR-140 Wall Mixer Non telephonic Shower	
 MIR-141 Wall Mixer 'L' Bend	 MIR-142 Wall Mixer Crutch	 MIR-143 Wall Mixer 3 in 1	
 MIR-150 Conceal 15mm	 MIR-151 Conceal 20mm	 MIR-151B Conceal 15mm+20mm	
 MIR-152 Flush Cock H/T	 MIR-152B Flush Cock O/T		
 MIR-154 Exposed Kit of Single Lever Concealed Diverter	 MIR-155 Exposed Kit of Single Lever Concealed High Flow Diverter	 MIR-180 Single Lever Wall Mounted Basin Mixer	
 MIR-191 Single Lever Basin Mixer			

 THR-101 Pillar Cock	 THR-102 Pillar Cock High Neck	 THR-105 Center Hole Basin Mixer with 450mm Braided Hoses	 THR-111 Bib Cock with wall flange
 THR-112 Long Body Bib Cock with wall flange	 THR-113B Bib Cock Two Way with wall flange	 THR-121 Angular stop Cock with wall flange	 THR-122 Angle Cock 2 way with wall flange
 THR-130 Sink Cock Casted Spout	 THR-131 Sink Cock J Spout	 THR-133 Sink Cock with Swivel Spout (Table Mount)	 THR-135 Sink Cock with bottom Swivel Spout
 THR-136 Sink Mixer J Spout	 THR-137 Sink Mixer with extender Spout	 THR-140 wall mixer Non Telephonic Shower Arrangement	 THR-141 wall mixer with L band
 THR-142 Wall Mixer with Crutch	 THR-143 Wall Mixer 3 in 1	 THR-150 A Conceal Stop Cock 15mm	 THR-151 Conceal Stop Cock 20mm
 THR-152 Concealed Flush Cock 25mm H/T	 THR-152 B Concealed Flush Cock 25mm O/T		

Orion

 ORI-101 Pillar Cock	 ORI-102 Pillar Cock High Neck	 ORI-105 Center Hole Basin Mixer	 ORI-103 Pillar Cock with Extended Body
 ORI-111 Bib Cock with wall flange	 ORI-112 Long Body bib cock with wall hung	 ORI-113 Bib Cock Two Way with wall flange	
 ORI-121 Angular stop Cock with wall flange	 ORI-122 Angle Cock dual handle with wall Flange	 ORI-130 Side Handle Sink Cock	 ORI-131 Sink Cock with Swivel Spout (wall Mount)
 ORI-132B Extended Flexible Sink Cock	 ORI-133 Sink Cock Swivel Spout (Table Mounted)	 ORI-134B Extended Flexible Swan Neck	 ORI-136 Sink Mixer With Swivel Spout (Wall Mounted)
 ORI-137B Extended Flexible Sink Mixer	 ORI-140 wall mixer Non Telephonic Shower Arrangement	 ORI-141 wall mixer with L bend	 ORI-142 Wall Mixer with Crutch
 ORI-143 Wall Mixer 3 in 1	 ORI-150 Conceal 15mm	 ORI-151 Conceal 20mm	 ORI-151B Conceal 15mm+20mm
 ORI-152 Flush Cock H/T	 ORI-152 B Flush Cock O/T	 ORI-181 Single Lever Basin Mixer With 450mm Braided Hoses	 ORI-182 Single Lever Basin Mixer Extended Body 450 MM with Braided Hoses
 ORI-154 Exposed Parts Kit of S/L Conc. Diverter	 ORI-155 Exposed Parts Kit of S/L Conc. High Flow Diverter	 ORI-180 Single Lever Wall Mounted Basin Mixer	





BATH SPOUT



ACN-193
Bath Spout with
Wall Flange



ADN-193
Bath Spout with Wall Flange



FRG-193
Bath Spout
with Wall Flange



CIS-193
Bath Spout
with Wall Flange



ILN-193
Bath Spout with Wall Flange



MIR-193
Bath Spout with
Wall Flange



ORI-193
Bath Spout With
Wall Flange



ACN-194
Bath Spout with Button
Attachment for Tele. Shower



ADN-194
Bath Spout with Button
Attachment for Tele. Shower



FRG-194
Bath Spout with Button
Attachment for Tele. Shower



CIS-194
Bath Spout with Button
Attachment for Tele. Shower



MIR-194
Bath Spout with button
Attachment for Tele. Shower



ORI-194
Bath Spout with Button
Attachment for Tele. Shower

FLUSH VALVES

Metropol Flush Valve Round Plate (Single Flow)

MFV-101 40mm
MFV-105 32mm
MFV-109 25mm



Metropol Flush Valve Round Plate (Dual Flow)

MFV-102 40mm
MFV-106 32mm
MFV-110 25mm



Metropol Flush Valve Square Plate (Single Flow)

MFV-103 40mm
MFV-107 32mm
MFV-111 25mm



Metropol Flush Valve Square Plate (Dual Flow)

MFV-104 40mm
MFV-108 32mm
MFV-112 25mm



CONCEALED BODIES



CB-101
Concealed body for 15mm Stop Cock Heavy



CB-101A
Concealed body for
15mm Stop Cock Medium



CB-102
Concealed body for
20mm Stop Cock



CB-103
Concealed body for
25mm Flush Cock H/T



CB-103B
Concealed body for
25mm Flush Cock Q/T



CB-105
Concealed body for Single Lever Diverter



CB-106
Concealed body for Single Lever High Flow Diverter

OVERHEAD SHOWERS



OHS-101
Overhead Shower Glaze With
SS Arm & Flange



OHS-102
Overhead Shower Mercury With
SS Arm & Flange



OHS-103
Overhead Shower Ocean With
SS Arm & Flange



OHS-104
Overhead Shower Rose With
SS Arm & Flange



OHS-105
Overhead Shower Water Fall Square 4"
(Multiflow) With SS Arm & Flange



OHS-106
Overhead Shower Square 4" With
SS Arm & Flange



OHS-107
Overhead Shower Maze 5" Round
With SS Arm & Flange

OVERHEAD SHOWERS



OHS-108
Overhead Shower Maze 4" Square
With SS Arm & Flange

OHS-109
Overhead Shower Aroma With
SS Arm & Flange

OHS-110
Overhead Shower Maze (SS 304)
A : 4" -
B : 6" -
C : 8" -



OHS-111
Overhead Shower Square (Brass)
A : 4" -
B : 6" -
C : 8" -
D : 12" -



OHS-112
Overhead Shower Trim



SA-101
Round Shower Arm 6" Brass



SA-102
SS Round Shower Arm
A : 9" -
B : 12" -
C : 15" -
D : 18" -



SA-103
SS Square Shower Arm
A : 9" -
B : 12" -
C : 15" -
D : 18" -

HAND SHOWERS

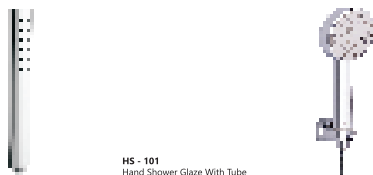

HS-100
Hand Shower Mist With Tube

HS-101
Hand Shower Glaze With Tube



HS-102
Hand Shower Ocean with Tube

HS-103
Hand Shower Super Square With Tube

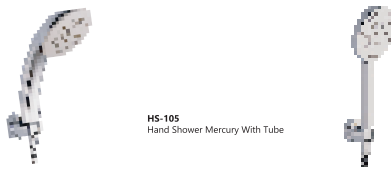

HS-104
Hand Shower Rose With Tube

HS-105
Hand Shower Mercury With Tube



HS-107
Hand Shower Trim
with Tube

HS-108
Hand Shower
Maze with Tube

HEALTH FAUCETS

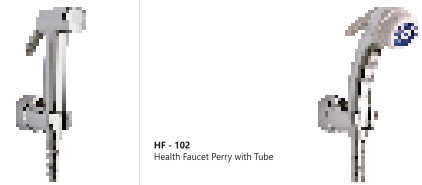

HF-101
Health Faucet Standard with Tube

HF-102
Health Faucet Perry with Tube

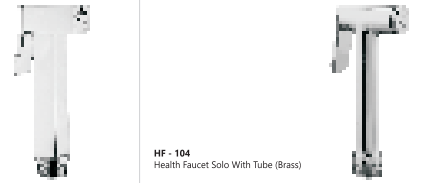

HF-103
Health Faucet Square With Tube (Brass)

HF-104
Health Faucet Solo With Tube (Brass)

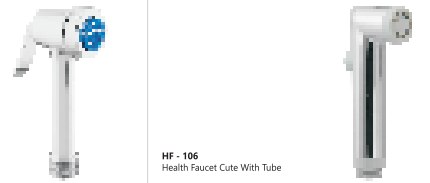

HF-105
Health Faucet Eco With Tube (Brass)

HF-106
Health Faucet Cute With Tube



HF-107
Health Faucet cube with tube

HF-108
Health Faucet Polo with tube

ALLIED ITEMS



ALL-101
Waste coupling
32mm Size Half Thread

ALL-102
Waste coupling
32mm Size Full Thread

ALL-103
Waste coupling Pop-up
32mm Size Full Thread



ALL-104
Bottle Trap

ALL-105
Project Angle Cock

ALL-108
Brass Push Cock



ALL-106
Nozzle Long Body
Bib Cock (Washing Machine)

ALL-107
Nozzle Long Body
Bib Cock (Garden)

ALL-115
Nozzle Bib Cock
(Garden)



ALL-116
Nozzle Bib Cock
(Washing Machine)

ALL-117
Jet Spray

ALL-118
Brass Push Angle Cock

ALL-109A Extension Nipple 1" (Brass)
ALL-109B Extension Nipple 1.5" (Brass)
ALL-109C Extension Nipple 2" (Brass)
ALL-109D Extension Nipple 2.5" (Brass)



ACUMEN
 SERIES
 Get Connected with Yourself

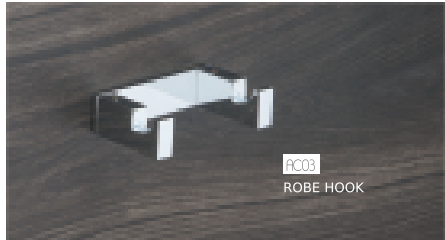
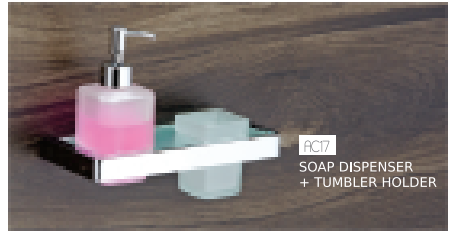

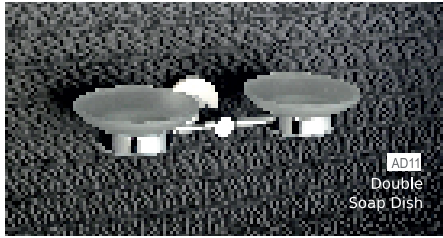

AD11
Double
Soap Dish

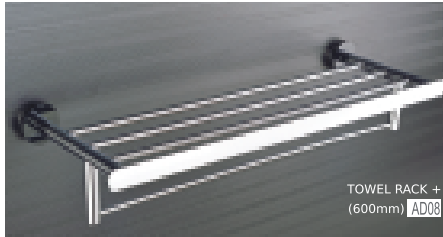

TOWEL RACK +
(600mm) AD08



TOWEL RACK
(600mm) AD07

ADONIS
 SERIES

A perfect blend of
 Art & Design
Brass & Acrylic
Chrome & Colors

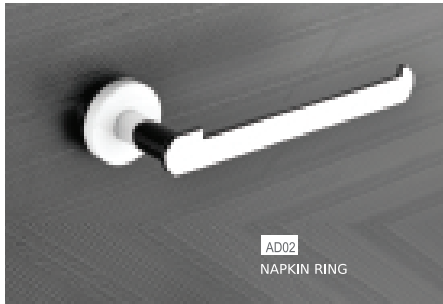

AD02
NAPKIN RING



AD04
SOAP DISH

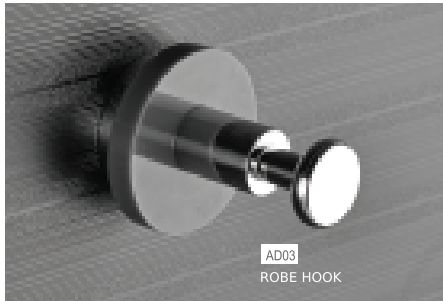

AD03
ROBE HOOK



AD10
BRASS SOAP DISH



AD06
LIQUID SOAP DISPENSER



AD05
TUMBLER HOLDER



TOWEL ROD
(600mm) AD01



AD09
TOILET PAPER HOLDER



star
 BATHWARE
 ACCESSORIES

43

VERNA
SERIES

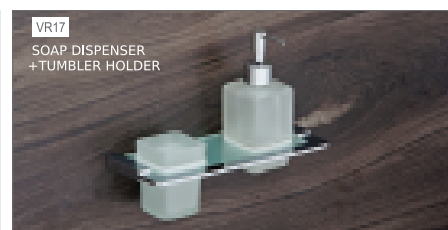
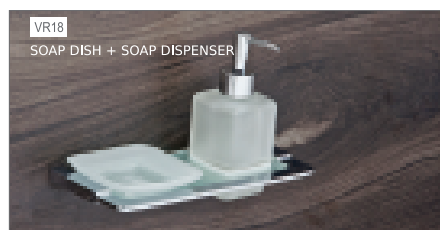
Accentuate
your Lavish
bathroom

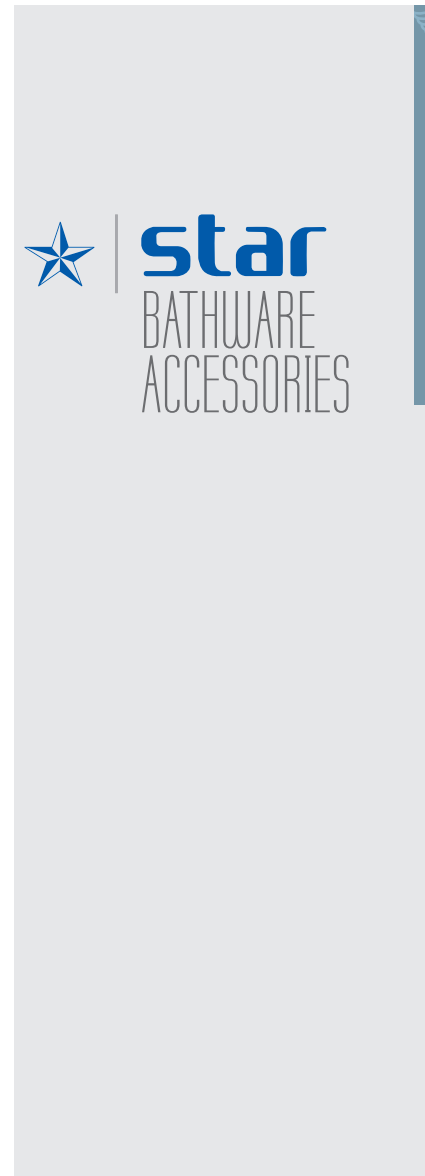
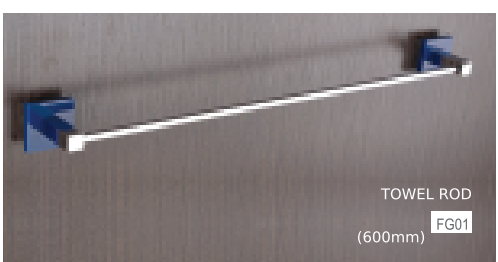
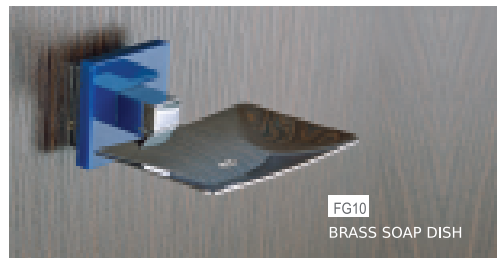
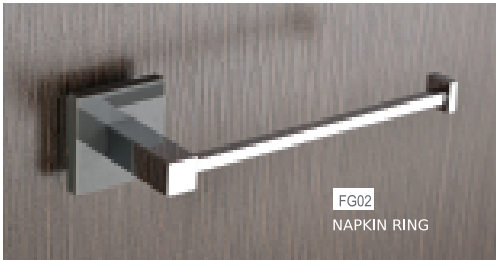
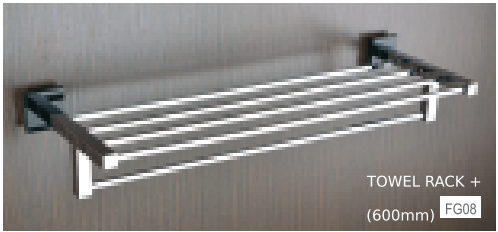
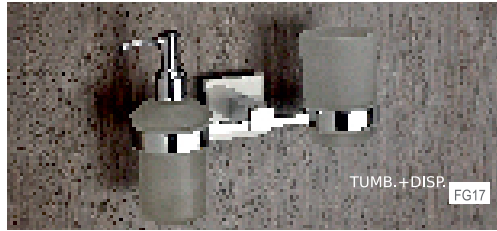
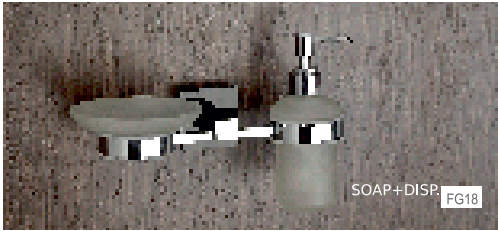



CISCO
 SERIES

A perfect blend of
 Art & Design
 Chrome & Colors

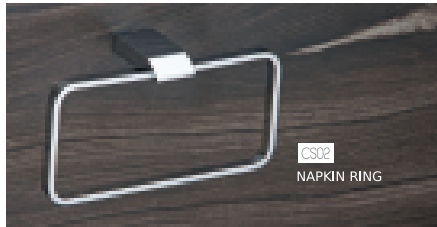
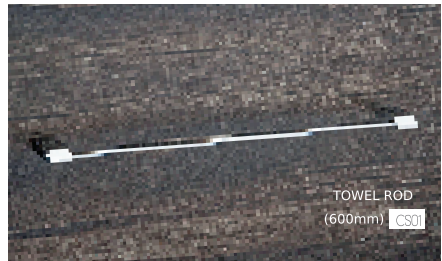
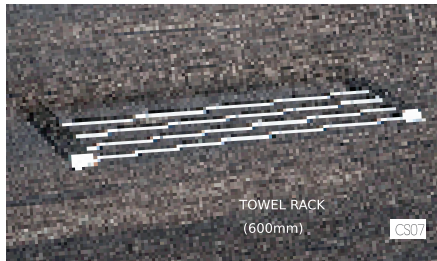
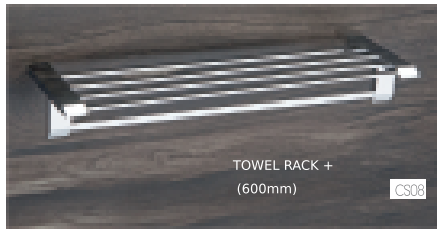

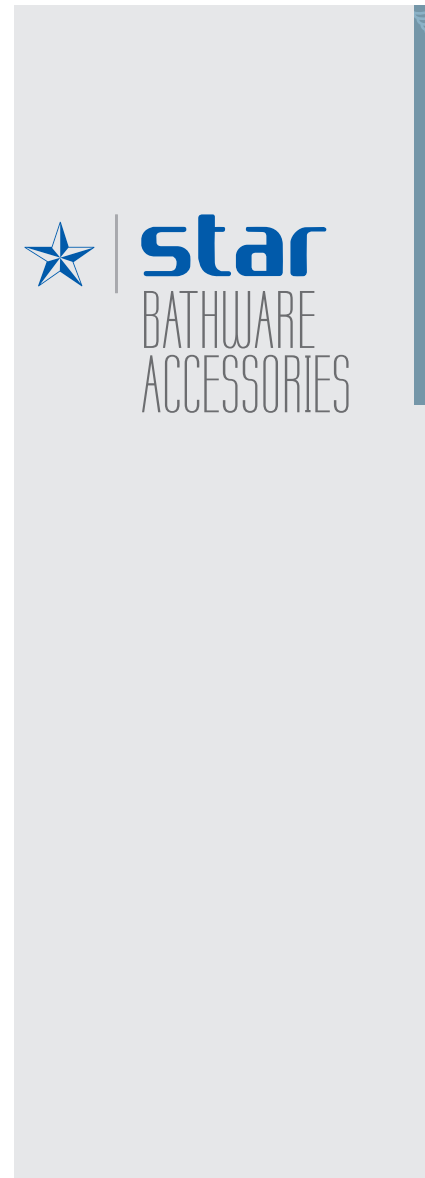
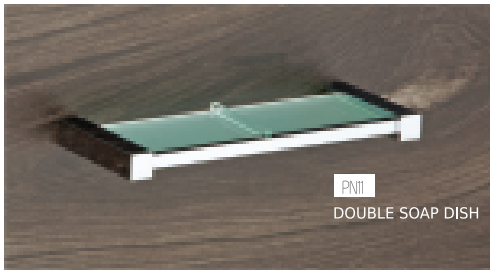
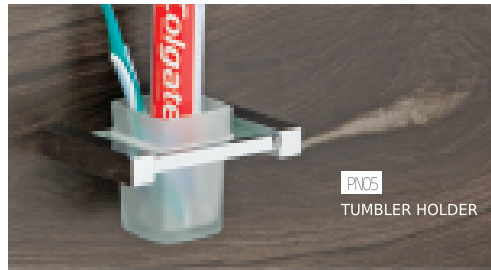
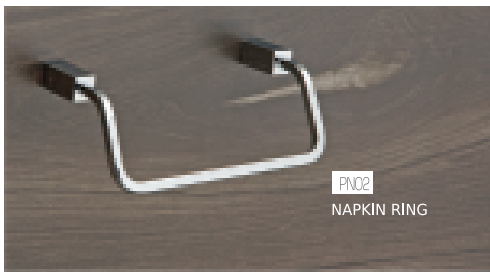

Illusion
SERIES
Scintillating Curves &
Chrome Finish

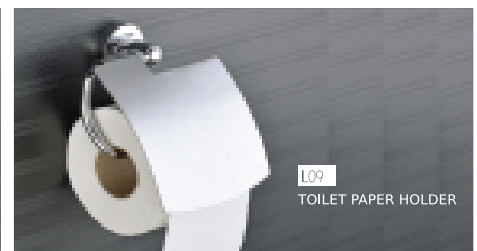
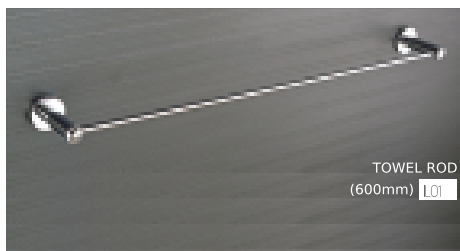
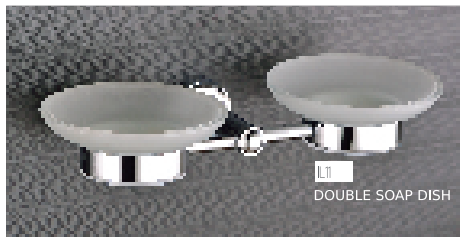
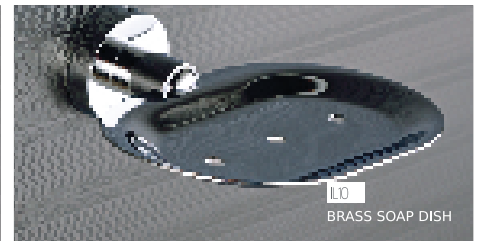
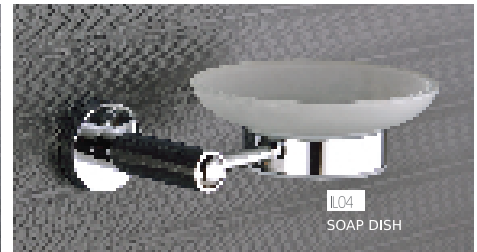
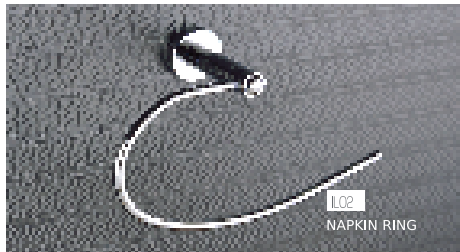
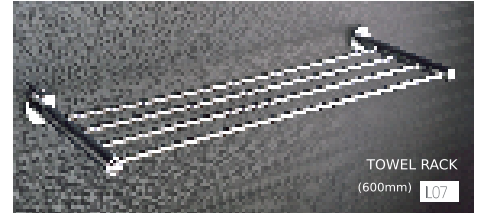
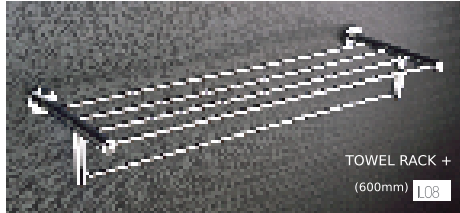
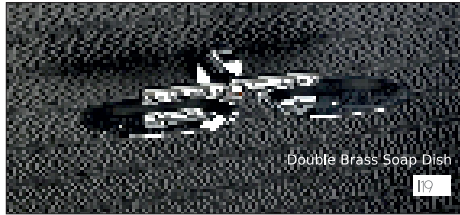

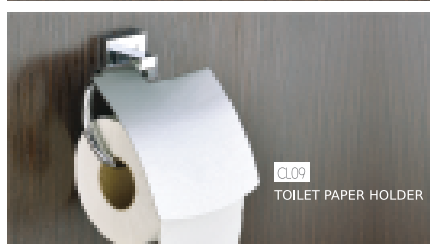
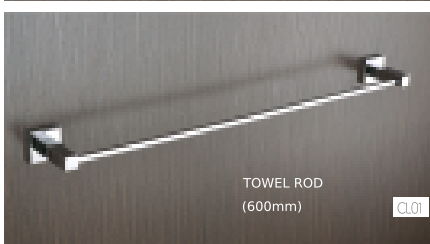
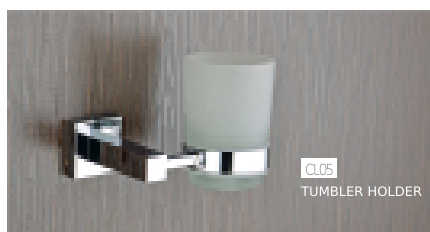
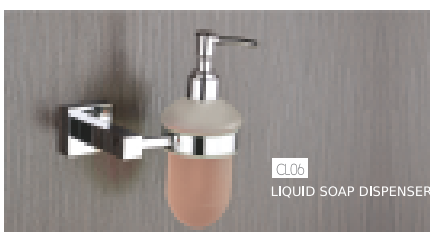
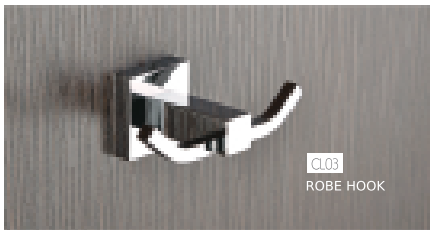
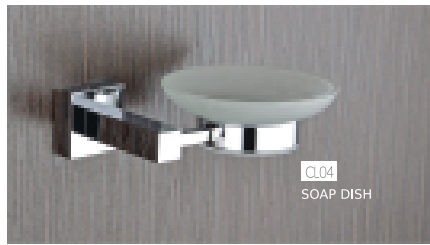
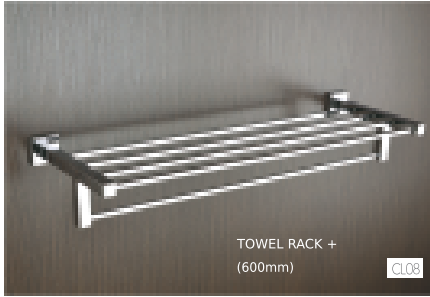





| **star**
SANITARYWARE



Your
PERSONAL Space
YOUR PERSONAL SPACE.
YOUR PERSONAL PRIDE.
Pride



MIA
7022 P & 9
One Piece Toilet - Washdown
Size:- 635 X 340 X 670 mm
Dual Flush; Soft Close seat cover
P' Trap - 300 mm
S' Trap - 225 mm



MIKE
7031 9 & 12"
One Piece Toilet - Wash down
Size - 640 x 360 x 735mm
Dual Flush; Soft Close seat cover
S' Trap 225/300 mm



EVELYN
7024 12", 9"
One Piece Toilet - Siphonic
Size:- 645 x 345 x 705 mm
Dual Flush; Soft Close seat cover
S' Trap - 225/300 mm



CANE
7033 9 & 12"
One Piece Toilet - Wash down
Size - 640 x 350 x 730mm
Dual Flush; Soft Close seat cover
S' Trap 300mm



ABIGAIL
7025 12", 9"
One Piece Toilet - Siphonic
Size:- 650 x 350 x 720 mm
Dual Flush; Soft Close seat cover
S' Trap - 225/300 mm



STAR LUX
7101
One Piece Toilet - Siphonic
Size - 680 x 490 x 650mm
Dual Flush; Soft Close seat cover
S' Trap 300mm



ISABELLA
7014 12
One Piece Toilet - Siphonic
Size:- 630 X 375 X 715 mm
Dual Flush; Soft Close seat cover
S' Trap - 200 mm / 300 mm



ELIZABETH
7027 4D/2D
One Piece Toilet - Siphonic
Size - 645 x 370 x 745
Dual Flush; Soft Close seat cover
S' Trap 300mm



STAR PRIME
7102
One Piece Toilet - Siphonic
Size - 660 x 420 x 620mm
Dual Flush; Soft Close seat cover
S' Trap 300mm



EMILY
7015 12", 8" & P
One piece toilet - Siphonic
Size :- 630 x 370 x 730
Dual Flush; Soft Close seat cover
S' Trap 300mm
P' Trap - 200 / 300 mm



OASIS
7028
One Piece Toilet - Wash down
Size :- 650 x 370 x 730mm
Dual Flush; Soft Close seat cover
S' Trap 225 P' Trap 180mm



STAR PRIDE
7103
One Piece Toilet - Siphonic
Size - 660 x 400 x 630mm
Dual Flush; Soft Close seat cover
S' Trap 300mm



CHARLOTTE
7018 8, 12 x P
One Piece Toilet - Washdown
Size:- 650 X 355 X 750 mm
Dual Flush; Soft Close seat cover
S' Trap 200/300mm
P' Trap 200/300mm



CAMILA
7030
One Piece Toilet - Siphonic 4D
Size:- 690 X 380 X 770 mm
Dual Flush; Soft Close seat cover
S' Trap 300mm



ZEDEX
ACU 300 12"
One Piece Toilet - Washdown
Size - 670 x 370 x 740
Dual Flush; Soft Close seat cover
S' Trap 230mm P' Trap 300mm



LUNA
ACU 301 S & P
Washdown
L 655 W365 H745 mm
S Trap 230/100 Mm
P Trap 230/100 Mm



AVELY
ACU 302
Siphonic 4D Flushing
L710 W375 H745 mm
S-Trap 230 Mm



AMAZE
ACU 318
One Piece Toilet Siphonic
Size :- 670 x 375 x 740 mm
'S' Trap 4D Flushing
300mm with PP Seat Cover



ROYAL
ACU 319
One Piece Toilet 4D Siphonic
Size :- 670X360X740 mm
'S' Trap 300mm with PP Seat Cover



COLORS
ACU 320 9"
One Piece Toilet 4D Siphonic
Size :- 670X360X760 mm
'S' Trap 225mm with PP Seat Cover



BRILLA
ACU 321 9", 12"
One Piece Toilet Siphonic
Size :- 695 x 395 x 760 mm
'S' Trap 225/300mm with
UF Seat Cover



CAROLINE
ACU 323 9"&P
One piece toilet - Washdown
Size - 642 x 365 x 726
Dual Flush; Soft Close seat cover
'S' Trap100mm (4")
'S' Trap225mm (9")
'p' Trap190mm



VANEESA-12
ACU 324
One piece toilet - Washdown
Size :- 650 x 360 x 710
Dual Flush; Soft Close seat cover
'S' Trap 300mm



LIVA
ACU 325
One piece toilet - Washdown
Size :- 650 x 360 x 710
Dual Flush; Soft Close seat cover
'S' Trap 300mm

ADONIS
Wall hung Toilet

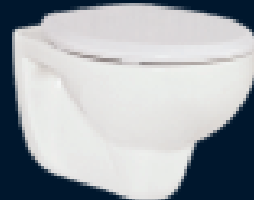

ADISON
4003
Wall-hung Toilet
Size:- 475 X 370 X 330 mm
Outlet-inlet Gasket,
Soft Close seat cover,



BELLA
4006
Wall-hung Toilet
Size:- 530 X 355 X 330 mm
Outlet-Inlet Gasket,
Soft Close seat cover,



NOVA
4007
Wall-hung Toilet
Size:- 530 X 350 X 360 mm
Outlet-inlet Gasket,
Soft Close seat cover,



RUBY
4010
Wall-hung Toilet
Size:- 535 X 350 X 355 mm
Outlet-inlet Gasket,
Soft Close seat cover,



IVY
4013
Wall-hung Toilet
Size:- 493 X 360 X 375 mm
Outlet-inlet Gasket,
Soft Close seat cover,



ALICE
4015
Wall-hung Toilet
Size:- 492 X 355 X 330 mm
Outlet-inlet Gasket,
Soft Close seat cover,



SARAH
4017-UF
Wall-hung Toilet
Size:- 515 X 350 X 330 mm
Outlet-inlet Gasket,
Soft Close seat cover,
Side cap- 2 pcs.



SARAH
4017-UF L-KEY
Wall-hung Toilet
Size:- 525 X 370 X 330 mm
Outlet-inlet Gasket,
Soft Close seat cover,
L-Key,



SARAH
4017-PP
Wall-hung Toilet
Size:- 525 X 370 X 330 mm
Outlet-inlet Gasket,
Soft Close seat cover,
L-Key,





star
SANITARYWARE



54



Your
PERSONAL Space
YOUR PERSONAL SPACE.
YOUR PERSONAL PRIDE.
Pride







**EVA
4019**

Wall-hung Toilet
Size:- 525 X 370 X 335 mm
Outlet-inlet Gasket,
Soft Close seat cover,
Side cap- 2 pcs.



**EVA
4019 -UF-LNK**

Wall-hung Toilet
Size:- 525 X 370 X 335 mm
Outlet-inlet Gasket,
Soft Close seat cover,
Side cap- 2 pcs.



**JULIA
4023 PP**

Wall-hung Toilet
Size:- 525 X 370 X 335 mm
Outlet-inlet Gasket,
Soft Close seat cover,
Side cap- 2 pcs.



**JULIA
4023-U/F**

Wall-hung Toilet
Size:- 525 X 370 X 335 mm
Outlet-inlet Gasket,
Soft Close seat cover,
Side cap- 2 pcs.



**ALEXA
4024-UF**

Wall-hung Toilet
Size:- 515 X 350 X 330 mm
Outlet-inlet Gasket,
Soft Close seat cover,



**AMY
9031 (Bidet)**

Wall-hung Toilet
Size:- 520 x 350 x 300 mm
Outlet-inlet Gasket,
Soft Close seat cover,
Side cap- 2 pcs.



**BROOKE
9032 (Bidet)**

Wall-hung Toilet
Size:- 525 x 370 x 310 mm
Outlet-inlet Gasket,
Soft Close seat cover,
Side cap- 2 pcs.



**EVA
ADN 201**

Wall-hung Toilet
RIMLESS
L 510 W 355 H365 MM



**LOTTIE
ADN 202**

Wall-hung Toilet
RIMLESS
L 505 W 355 H385 MM



**PHOEBE
ADN 203**

Wall-hung Toilet
RIMLESS
L 493 W 355 H350 MM



**ZARA
ADN 405 S**

Wall-hung Toilet
S Trap 100 mm
I510 W365 H395



**ZARA
ADN 405 P**

Wall-hung Toilet
P Trap 170 mm
I510 W365 H395



**REA
ADN 600**

Wall-Hung Toilet
Size :- 525 x 345 x 390
Outlet-inlet Gasket
Soft Close seat cover



**CORE
ADN 601**

Wall-Hung Toilet
Size :- 515 x 360 x 350
Outlet-inlet Gasket
Soft Close seat cover



**EDENA
ADN 602**

Wall-Hung Toilet
Size :- 530 x 390 x 370
Outlet-inlet Gasket
Soft Close seat cover

Fragrance One piece Basin



8001
One piece Basin
Size:- 355 X 355 X 295 mm



8002
One piece Basin
Size:- 370x355x355



8003
One piece Basin
Size:- 470 X 430 X 300



8005
One piece Basin
Size:- 380 X 350



8008
One piece Basin
Size:- 475 X 430 X 870 mm



FRG 801
Wall Mounted Basin
L480 W430 H332mm



FRG 802
Wall Mounted Basin
L510 W430 H363mm



FRG 601
Wall Mounted Basin
L400 W385 H280 mm



FRG 602
Wall Mounted Basin
L380 W370 H250 mm



ILLUSION
Full & Half Pedestal Basin

1007 & 2002 FP
1007 Basin
2002 Full Pedestal
Size:- 573 X 460 X 830 mm



1013 & 2001 FP
1013 Basin
2001 Full Pedestal
Size:- 580 X 410 X 850 mm



1014 & 2002 FP
1014 Basin
2002 Full Pedestal
Size:- 505 X 410 X 835 mm



1016 & 2002 FP
1016 Basin
2002 Full Pedestal
Size:- 560 x 475 x 850 mm



1017 & 2002 FP
1017 Basin
2002 Full Pedestal
Size:- 600 X 435 X 860 mm



1007 & 2005 HP
1007 Basin
2005 Half Pedestal
Size:- 570 X 460 X 490 mm



1015 & 2006 HP
1015 Basin
2006 Half Pedestal
Size:- 520 X 410 X 445 mm



1020 & 2005 HP
1020 Basin
2005 Half Pedestal
Size:- 510 X 370 X 410 mm



1021 & 2010 HP
1021 Basin
2010 Half Pedestal
Size:- 500 X 400 X 450 mm



3012 & 2006 HP
Small Basin
Size:- 500 X 400 X 420 mm



3101 HP & 2101 HP
L465 W355 H410 mm
3101 Basin
2101 Half Pedestal



3102 HP & 2102 HP
L410 W378 H395 mm
3102 Basin
2102 Half Pedestal



3103 HP & 2103 HP
L465 W360 H400 mm
3103 Basin
2103 Half Pedestal



3100 HP & 2100 HP
L432 W565 H430mm
3100 Basin
2100 Half Pedestal



5034
Table Top Basin
410 X 335 X 140 MM



5035
Table Top Basin
405X405X150mm



5107
Table Top Basin
L545 W395 H112 mm



5109
Table Top Basin
L495 W385 H133 mm

CISCO
Thin Rim
Collection
Table Top



5002
Table Top Basin
415X360X175mm



5036
Table Top Basin
625X390X145mm



5118
Table Top Basin
600x400x120mm



5026
Table Top Basin
690X390X140mm



5042
Table Top Basin
420X310X150mm



5119
Table Top Basin
710x385x145mm



5028
Table Top Basin
430X430X130mm



5046
Table Top Basin
550X360X125mm



5120
Table Top Basin
450x325x150mm



5033
Table Top Basin
490X400X150mm



5047
Table Top Basin
800X360X130mm



5121
Table Top Basin
430x335x130mm

CISCO Thin Rim Collection Table Top



5122
Table Top Basin
400x400x136mm



5055
Wall Mounted Basin
465x360x173mm



5059
Wall Mounted Basin
L345 W345 H140 mm



3014
Small Basin
Size:- 450 X 340 X 445 mm



5056
Wall Mounted Basin
475x360x180mm



5060
Wall Mounted Basin
L400 W400 H170



5011
Wall Hung Basin
460X355X125mm



5057
Wall Mounted Basin
400x320x145mm



5062
Wall Mounted Basin
L400 W400 H170



5017
Wall Hung Basin
410X410X150mm



5040
Under Counter Basin
315X405mm



5063
Wall Mounted Basin
L400 W400 H170



5053
Wall Hung Basin
455X400X145mm

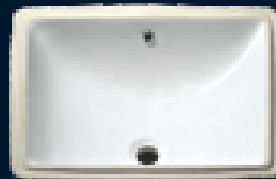

5041
Under Counter Basin
345X440mm

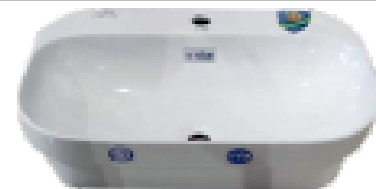

5066
Wall Mounted Basin
L400 W400 H170



5054
Corner Basin+
565x480x182mm



5058
Wall Mounted Basin
L410 W375 H155 mm



5067
Wall Mounted Basin
L400 W400 H170





5071
Wall Mounted Basin
L400 W400 H170



5073
L400 W400 H170

CORAL WASH BASIN



3002
Small Basin
Size:- 460 X 335 X 170 mm



3003
Small Basin
Size:- 355x355x135 mm



3006
Small Basin
Size:- 465 X 365 X 175 mm



3023
Small Basin
335 x 365 x 140 mm



3024
Small Basin
345 x 345 x 140 mm



3022
Small Basin
420 X 245 X 130 MM



3016
Small Basin
455 x 370 x 420 mm



6004 S
WATER CLOSET
530x455x415mm
Seat Cover extra



6004 P
WATER CLOSET
530x455x415mm
Seat Cover extra



6006 S
WATER CLOSET
475x365x400mm
Seat Cover extra



6006 P
WATER CLOSET
475x365x400mm
Seat Cover extra

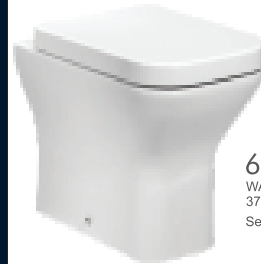

6010 P & S
WATER CLOSET
375x460x400mm
Seat Cover extra



CRN WC 404 P & S
EWC P Trap, S Trap
L525 W370 H410 MM
Seat Cover extra



CRN WC 401 P & S
ANGLO INDIA -
S TRAP, P TRAP
L555 W460 H410 MM
Seat Cover extra



CRN WC 403 (N)
CONCEALED
L565 W340 H410 MM
Seat Cover extra



CRN WC 403 (O)
CONCEALED
L530 W370 H400 MM
Seat Cover extra

CORAL WATER CLOSET





star
SANITARYWARE

CORAL URINAL



9002, 7009
Urinal
Size:- 340 X 330 X 570 mm



9005
Urinal
Size:- 325 x 285 x 460mm



CRN BWU 501
L530 W385 H630 MM



CRN BWU 502
L230 W260 H505 MM



CRN BWU 503
L295 W335 H550 MM



CRN BWU 601
L290 W300 H390 mm



6001-Orissa 21"
Orissapan 21"
Size:- 685 X 360 X 725 mm



6002-Orissa 23"
Orissapan 23"
Size:- 685 X 360 X 725 mm



6003-C.T PAN 20"
Size:- 685 X 360 X 725 mm



6101 Wit 23"
Orissa pan
L587 W450 H310 MM



6102 Wit 20"
Orissa pan
L525 W420 H285 MM



A PRODUCT FROM



star

High Quality means durability.



star bond BALL VALVE



Size in mm	Size in Inch
20	1/2"
25	3/4"
32	1"
40	1 1/4"
50	1 1/2"
63	2"



Vision

Our vision is to become the most reliable provider of high quality PVC products to meet the diverse requirements of potable water distribution, domestic plumbing, borewells and lift irrigation purposes. We aim to make each of our products a paragon of quality and technical excellence. Through our constant endeavours of research and innovation we strive to come up with new products that help architects and builders keep ahead of the times.

Philosophy

A Customer is the most important visitor on our premises.

He is not dependent on us.
We are dependent on him.

He is not an interruption on our work.
He is the purpose of it.

He is not an outsider on our business.
He is a part of it.

We are not doing him a favour by serving him.
He is doing us a favour by giving us
an opportunity to do so.

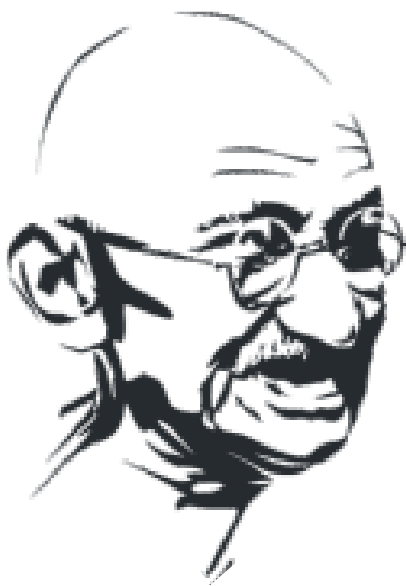



PIPE & FITTINGS | SANITARYWARE | BATHWARE | WATER TANKS | STAR FLEX | STARPAULIN



Quality policy

It is our policy to manufacture and market goods, which conform to the customer's requirements. We consider customer satisfaction as the basic philosophy of our organisation.

Quality objectives

To consistently manufacture and supply products which meet with the customer's requirements.

To maintain an effective quality management system through active involvement of all employees.

To always ensure timely delivery of products.

To reflect quality in all our activities.



star
PIPES & FITTINGS

**KERALA
THRISSUR**

Pipes: 0487-2213678, 2213679, 2213680;
Fax: 0487-2213684, Email : starpvcpipes@gmail.com
Fittings: 0487-2386764, 2386763, 2386764
Fax: 0487-2386924, Email: mail@starpipes.in

**TAMIL NADU & ANDHRA PRADESH
CHENNAI**

Pipes: 044-27658236, 27658087, 27658088;
Fax : 044-27658235; Email : starpipes@gmail.com
Fittings : 044-25220102, 25225083,
Fax : 044-25241216, Email:cnl@starpipes.in

**KARNATAKA
BANGLORE**

Phone: 080-26575392, 26574391
Fax: 26570139
E-mail:blr@starpipes.in

**THIRUVALLUR-
MAHARASHTRA**

No. 135, Ulundai Village, Poonamalle, Arakonam Road,
Thiruvallur Dist. Pin: 602105. Ph: 044 - 27658236,
087 Mob: 88837 77223
Email: starpipes@gmail.com, tvr@starpipes.in

**U A E
DUBAI**

Phone: 009714 - 3474977, 83;
Fax : 3473949
Email: dxb@starpipes.in

web: www.starpipes.in